

Basic
American[™]
by graham-field

ZENITH[™]
SERIES

Zenith **SERIES**



MODEL ZENITH 9000 SERIES
WITH PEDAL LOCK AND
ADVANCED POSITIONING (APS)
FEATURES

INSTRUCTIONS FOR USE

*To avoid personal injury or damage to bed,
read all sections pertaining to the bed model before use.*

FDA Recognized Standard:
ANSI/AAMI STD ES60601-1

Health Canada Recognized Standard:
CAN/CSA C22.2 No. 60601-1 (IEC 60601-1:2012-Ed.3.1)

Includes International Standards:
IEC 60601-1, IEC 60601-1-2, IEC 60601-2-52

EMC Standard:
IEC 60601-1-2 Ed. 4.0

TABLE OF CONTENTS

IMPORTANT SAFETY AND WARNING INFORMATION..... 3
 IMPORTANT SAFETY AND WARNING INFORMATION 4
 ELECTROMAGNETIC COMPATIBILITY (EMC) INFORMATION..... 4
 ENTRAPMENT AND COMPLIANCE INFORMATION..... 5
 RECOMMENDED MAINTENANCE 6
 MECHANICAL AND ELECTRICAL INFORMATION 7
 OPERATING CONDITIONS 8
 STORAGE AND TRANSPORT CONDITIONS 8
 DISPOSAL OF EQUIPMENT AND ACCESSORIES 8
 BED SETUP AND OPERATION INSTRUCTIONS..... 9
 UNPACKING THE BED 9
 HEADBOARD AND FOOTBOARD ASSEMBLY / INSTALLATION 10
 SLIDE-W-I-D-E HEADBOARD AND FOOTBOARD POSITIONS USING THE QUICK-RELEASE DETENT PINS. 11
 STANDARD MATTRESS RETAINER INSTALLATION 12
 MATTRESS RETAINER INSTALLATION FOR OPTIONAL SLIDE-W-I-D-E DECK 13
 STANDARD WIREFORM WALLSAVER INSTALLATION..... 14
 OPERATING THE OPTIONAL CASTER PEDAL LOCK MECHANISM..... 15
 PLUGGING IN THE FOOTBOARD STAFF CONTROL..... 15
 ZENITH SERIES OPTIONAL ACCESSORIES.....16
 OPERATION OF OPTIONAL SLIDE-W-I-D-E 35" - 39" - 42" EXPANDABLE / RETRACTABLE SLEEP DECK..... 19
 IMPORTANT SAFETY AND WARNING INFORMATION 19
 FEATURES..... 19
 SLIDE-W-I-D-E SLEEP DECK POSITIONING..... 20
 BED OPERATION 21
 ZENITH SERIES HAND CONTROL PENDANT OPERATION 21
 BED OPERATION - OPTIONAL STAFF CONTROL PANEL * 22
 BED OPERATION - CHAIR POSITION 23
 BED OPERATION - TRENDELENBURG / REVERSE TRENDELENBURG POSITION 24
 TROUBLESHOOTING 26
 NOTHING WORKS — NO POWER..... 26
 AUDIBLE SYSTEM WARNING (INTERMITTENT BEEP) 26
 KNEE DOESN'T LOWER, AUDIBLE SOLID BEEP WARNING 27
 GENERAL TROUBLESHOOTING QUICK REFERENCE 28

These Instructions for Use cover the Zenith Series with Standard and Advanced Positioning (APS), Standard Casters and Pedal-Lock option, for Standard Deck and Slide-W-I-D-E® Deck.

The Zenith Series is designed for Adult Patient and Caregiver use.

To order Zenith Series Bed service parts, contact a GF Health Products, Inc. customer service representative at 1-770-368-4700.

For a list of Zenith Series bed service parts, visit www.grahamfield.com.

To order a Zenith Series bed or accessories, contact a GF Health Products, Inc. sales representative at 1-770-368-4700.

Important Notice: Check all parts for shipping damage and test before using. In case of damage, DO NOT USE — contact qualified service personnel for examination and repair.

LABEL SYMBOL DEFINITIONS

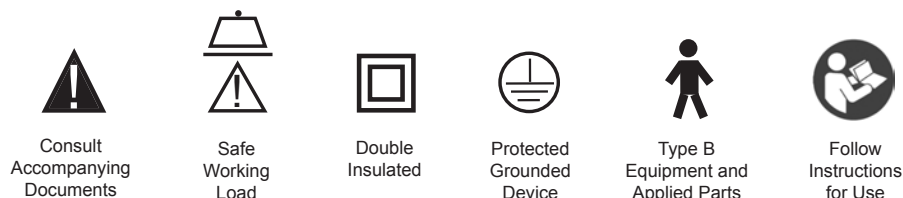

IMPORTANT SAFETY AND WARNING INFORMATION

 This product is a variable height, adjustable mattress platform. The expected service life of this product is fifteen years. Beds manufactured by Basic American Medical Products are designed for use within an institutional healthcare environment (i.e. assisted living, skilled nursing, transitional care, rehabilitation care, Environment (3), as defined in IEC60601-2-52 Safety Standard.)

 The maximum safe working load for the Zenith 7000 series bed, including bedding, resident / patient, support surface, and accessories, is 500 lb (226.8 kg), with weight evenly distributed, and maximum patient weight is 450 lb (204.1 kg).

The maximum safe working load for the Zenith 9000 series bed, including bedding, resident / patient, support surface, and accessories, is 600 lb (272.2 kg), with weight evenly distributed, and maximum patient weight is 550 lb (249.5 kg). Accessory weights follow:

ACCESSORY DESCRIPTION	WEIGHT
Extension Kit, Standard Width	12 lb (5.4 kg)
Extension Kit, Wide	14 lb (6.4 kg)
Trapeze Adapter	13 lb (5.9 kg)
Trapeze	16 lb (7.3 kg)
Half Counter-Rotating Assist Device (Set of 2)	21 lb (9.5 kg)
Fixed Assist Bar, Head	6 lb (2.7 kg)
Pivoting Assist Bar	10 lb (4.5 kg)

 **WARNING:** To avoid risk of electric shock, this equipment must be connected to a supply mains with protective earth (i.e. a grounded outlet).

 **DO NOT** open assemblies such as the Actuators, Hand Control Pendant, or Control Box. If unauthorized personnel perform work on these components, the manufacturer's warranty becomes void.

 **DO NOT** use unauthorized parts, accessories, or adapters other than those specified / authorized by GF Health Products, Inc.

 When operating the HI/LO, Knee, or Back Functions of the bed, **ALWAYS** ensure the confined individual is positioned properly within the confines of the bed. **DO NOT** let any extremities protrude over the side or between the bed rails when performing these functions.

 The bed should be lowered to lowest position when resident is left unattended. **DO NOT** lower the bed when objects are beneath it. Failure to inspect under the bed can result in personal injury or property damage.

 The bed's Hand Control Pendant Cable **MUST BE ROUTED AND SECURED PROPERLY** to ensure it does not become entangled and eventually severed during use. Also ensure electrical cords **DO NOT** get tangled around the bed, side rails, or legs during transport or normal operation of the bed.

 When using nasal-type or masked-type administering equipment, all oxygen or air tubing **MUST BE ROUTED AND SECURED PROPERLY** to ensure the tubing does not become entangled and eventually severed during the normal operation of the bed.

 Keep all moving parts free of obstructions (i.e. blankets / sheets, heating blankets / pads, wiring, etc.).

 **DO NOT** use the assist devices as push handles for moving the bed. Assist devices can be deformed or broken if excessive side pressure is exerted. Assist devices are not meant for patients considered high risks for entrapment (i.e. patients with pre-existing conditions such as confusion, restlessness, lack of muscle control, altered mental status, either organic or medicinal, or a combination thereof). Additional safety measures should be considered for such high-risk patients.

 **NEVER** permit more than one person on / in the bed at any time.

 Body weight should be evenly distributed over the sleeping surface of the bed. **DO NOT** allow the patient to lie, sit, or lean in such a way that their entire body weight is placed only on the raised head or foot section of the bed. This especially applies when repositioning or transferring a patient in or out of the bed. Increased risk may occur when the patient's size and / or weight are inappropriate for the bed's dimensions or weight capacity.

 Risk of entanglement or injury may occur if the mattress used with mattress retainers does not fill the entire width between stops or which compresses to less than 1.50 inches under user's weight.

 Mattress must be properly sized to fit the mattress support platform and must remain centered on the support platform relative to State and Federal guidelines. Recommended minimum dimensions of mattress are 35-36 inches wide and 6 inches deep. Length and width should match the mattress support platform. Use of an improperly fitted mattress could result in injury or death.

IMPORTANT SAFETY AND WARNING INFORMATION



IMPORTANT: Powered air mattress surfaces may pose a risk of entrapment. Prior to use, ensure the therapeutic benefits outweigh the risk of entrapment.



The bed is intended for use within a temperature range of 10°C to 40°C. It has a water resistance rating of IPX4 and IS NOT to be power washed or submerged. The bed may be cleaned as needed using an appropriate dilution of mild soap and water.



The head / back and knee / foot decks can be lifted freely by hand for easy cleaning access when patients are not in the bed. If you lift the head / back or knee / foot deck for any reason, take great care when lowering back down to the prone position - ensure all body parts are clear of the space between the deck and the bed prior to slowly lowering any deck manually. To avoid injury, **DO NOT LET DECKS FALL FREELY FROM ANY ANGLE.**



WARNING: Notice for California Customers - California Proposition 65 **WARNING:** This product can expose you to chemicals including DEHP which is known to the State of California to cause cancer and birth defects or other reproductive harm. For more information go to www.P65Warnings.ca.gov/product.



WARNING: ALWAYS position bed so that the power cord and plug are easily accessed.



Proper routing and tie-off of electrical cabling, especially the power cord, is essential for proper operation and to ensure safety from electrical shock. In the event you are replacing any electrical cabling on your bed, you must ensure the cables are free from pinch points, obstructions, or stretched so tight that they may come loose or become damaged. In addition, cables should be tied off in such a way to secure them and keep them free from tangling on any part of the bed during normal operation. Refer to page 25 for proper cable routing.

ELECTROMAGNETIC COMPATIBILITY (EMC) INFORMATION



WARNING: Medical Electrical Equipment needs special precautions regarding EMC and needs to be installed and put into service according to the EMC information provided in this manual.



WARNING: Electronic equipment may be influenced by Radio Frequency (RFI). Caution should be exercised with regard to the use of portable communications in the area around such equipment. Portable RF communications equipment (including peripherals such as antenna cables and external antennas) should be used no closer than 30 cm (12 inches) to any part of the bed including specified bed cables. Degradation of the performance of the bed could result.



IF RFI causes erratic behavior, unplug the electric bed immediately. Leave unplugged while transmission is in progress.



WARNING: The use of accessories, transducers, and cables other than those specified by the manufacturer may result in increased emissions or decreased immunity of the bed. GF Health cables and accessories include motor cables, mains cable, pendant cables, back up battery and cable, USB port cable and UBL and cable.



WARNING: This bed should not be used adjacent to or stacked with other equipment. If adjacent or stacked use with other equipment is necessary, this bed and the other equipment should be observed to verify that they are operating normally.



WARNING: The EMISSIONS characteristics of this equipment make it suitable for use in industrial areas and hospitals (CISPR 11 class A). If it is used in a residential environment (for which CISPR 11 class B is usually required) this equipment might not offer adequate protection to radio frequency communication services. The user might need to take mitigation measures, such as relocating or re-orienting the equipment.

ENTRAPMENT AND COMPLIANCE INFORMATION

On April 10, 2006, the FDA (U.S. Food and Drug Administration) released long-awaited guidelines for reducing the risk of bed entrapment: “Hospital Bed System Dimensional and Assessment Guidance to Reduce Entrapment”. The new Guidance identifies potential entrapment areas and those body parts most at risk for entrapment; provides design criteria for manufacturers of new hospital/convalescent beds; recommends particular test methods to assess the conformance of existing hospital / convalescent bed systems; and answers frequently-asked questions about entrapment issues.

The new Guidance was a result of a long-standing collaboration between the FDA and the Hospital Bed Safety Workgroup (HBSW), formed in 1999. GF Health Products, Inc.’s Long Term Care Bed division: Basic American Medical Products, is an HBSW charter member. As a result of our commitment to product safety, **all our current long-term care beds have been strictly tested and conform to the new FDA Guidance.**

The guidelines set forth by the FDA Guidance lay out specific dimensional limitations on potentially injury-threatening gaps and spaces that can occur between bed system components, such as rails, when not properly installed. GF Health Products, Inc. and Basic American Medical Products have conformed to these guidelines from a manufacturing aspect. However,

entrapment issues can often arise when a healthcare provider / facility has not correctly assembled the components on a bed. It is essential that the provider / facility fully understand their responsibility in complying to the guidelines set forth by the FDA in order to avoid injury. To that end, we have provided the FDA’s web address at right as a resource for understanding and following these guidelines for the safety of patients / residents.

It is also essential to have the correct bed components / accessories that correspond with the needs of the patient / resident and the particular bed you have purchased. Matching the correct bed component that correlates with the regulatory guidelines can be a daunting task. Our sales team at GF Health Products, Inc. and our friendly Customer Service Representatives at Basic American Medical Products can help you sift through the wide array of compliance and bed options. We will help you determine which bed / bed part is best for the patient’s / resident’s particular needs and help you with any compliance issues.

The Zenith series bed and accessories listed in these instructions are in full compliance with FDA guidelines for reducing the risk of bed entrapment: “Hospital Bed System Dimensional and Assessment Guidance to Reduce Entrapment”.

Details can be found at www.fda.gov.

RECOMMENDED MAINTENANCE

Regular maintenance of the Long Term Bed is necessary to ensure continuing proper and safe operation. Read and observe the following recommended maintenance schedule. Additional Maintenance Log pages are available at the end of these instructions.

ITEM	RECOMMENDED INSPECTION PERIODS			MAINTENANCE		
	Inspect on Receipt	Every 3 Months	Every 6 Months	Performed by	Date	Comments
Maintenance Inspection of All Components at Receipt of Shipment						
Ensure all parts / components are included (see "Unpacking The Bed").	X					
Check all bed components for obvious damage.	X					
Inspect the power cord for any cuts and / or damage.	X					
Check to see all actuator / motor cables are routed and connected properly to the control box.	X					
Mechanical Inspection of Assemblies						
Inspect all welds on the sleeping surface, frame, and base assemblies for stress fractures.			X			
Inspect all fasteners for wear and looseness.			X			
IMPORTANT: Lubricate all pivot points, actuator / motor clevis pins, and control arm clevis pins as needed. White Lithium Grease is recommended.			X			
Mechanical Inspection of Casters and Pedal Locking Mechanism						
Check the pedal locking mechanism to ensure it engages and disengages properly.		X				
Check the casters and stationary foot pads on both the head end and foot end for any damage, wear, or debris. Replace if needed.		X				
Check all rolling casters to ensure that they roll properly and are unobstructed.		X				
Electrical Inspection of Control Box, Hand Control Pendant, and Staff Control						
Check the external power cord that plugs into the control box for any chafing, cuts, or wear. Replace if damaged.		X				
Ensure all attaching hardware is securely tightened.		X				
Check all electrical connections for wear or fractures.		X				
Check the external backup battery (if you have one). Replace if needed.		X				
Check the hand control pendant cable for chafing, cuts, or wear.		X				
Check all hand control pendant functions - check to ensure each button and associated function work properly (i.e. head section rises when the HEAD UP button is activated).		X				
Electrical Inspection of Actuators / Motors						
Check the actuator / motor cables for any chafing, cuts, or wear.		X				
Check the range of movement on all motors to ensure they do not bind in the Full Up or Full Down positions.		X				

MECHANICAL AND ELECTRICAL INFORMATION

ZENITH SERIES-MECHANICAL		<i>NOTE: All dimensions are ±0.25 inches</i>			
Specification		7100	9100	7100 with SLIDE-W-I-D-E	9100 with SLIDE-W-I-D-E
Overall Bed Length (with boards and wallsaver)	76"	82"	82"	82"	82"
	80"	86"	86"	86"	86"
Sleep Deck Width		35"	35"	35"-39"-42"	35"-39"-42"
Bed Width Including Boards		36"	36"	36" or 42"	36" or 42"
Maximum Height (floor to top of mattress support deck)		30"	30"	30"	30"
Minimum Height (floor to top of mattress support deck)		7.95"	7"	7.95"	7"
Maximum Head / Back Deck Angle		68°	68°	68°	68°
Maximum Knee / Foot Deck Angle		25°	25°	25°	25°
Maximum Trendelenburg / Reverse Trendelenburg Angle (APS models)		15°	14°	15°	14°
Maximum Safe Working Load WITH WEIGHT EVENLY DISTRIBUTED - includes bedding, resident / patient, support surface, and accessories		500 lb (226.8 kg)	600 lb (272.2 kg)	500 lb (226.8 kg)	600 lb (272.2 kg)
Bed Mass (standard deck, without assist devices or boards)		204 lb (92.5 kg)	218 lb (98.9 kg)	227 lb (102 kg)	241 lb (109.3 kg)
ZENITH SERIES-ELECTRICAL (ALL MODELS)					
Power / Frequency		120 Volt / 50/60 Hz			
Output Rating		24Vdc			
Maximum Amperage		4.5 Amps			
Classification		Class 1, Type B			
Power (Electrical) Cord		#18 AWG 3 Conductor Type SJT			
Mode of Operations		10% Max. Duty Cycle (2 minutes on / 18 minutes off)			
<i>Battery Pack and Charger can be purchased separately as accessories.</i>					

TYPICAL ZENITH SERIES BED IDENTIFICATION LABELS with Grounded Electrical Cable

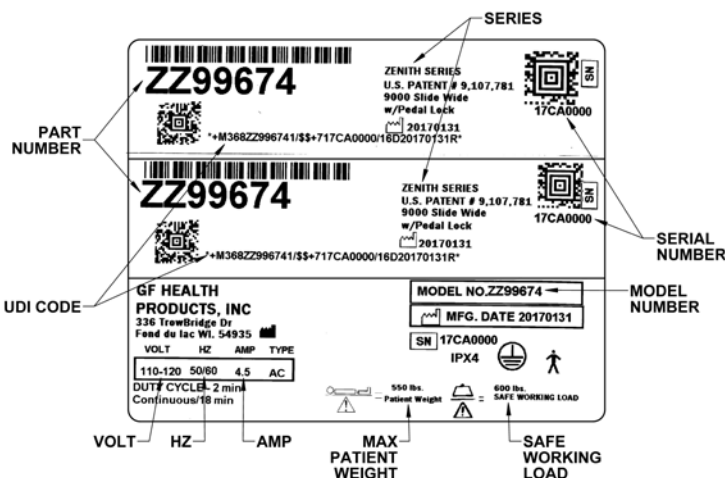

Bed labels are an important part of identifying the bed's make and model when ordering replacement parts. The Serial Number is essential if you are claiming parts or service under warranty. These helpful labels can be located on the main frame rails, immediately below the sleep decks on either side of the bed.

Have this IMPORTANT information ready when calling our Customer Service or Technical Support staff at 1-770-368-4700; it will allow us to better assist you and quickly answer your questions and concerns.

WARNING: Do not modify this equipment without authorization from GF Health Products, Inc.

NOTE: For Zenith Series Service Parts, Technical Assistance, and Information, call our Customer Service Department at 1-770-368-4700. For a list of Zenith Series bed service parts, visit www.grahamfield.com.

The following warning labels have been placed on the bed to help protect you and the bed from damage. Do not remove any labels from the bed.

WARNING!

DO NOT LOWER BED WHEN OBJECTS ARE BENEATH BED. FAILURE TO INSPECT UNDER BED CAN RESULT IN DAMAGE TO PROPERTY OR PERSONAL INJURY.

ATTENTION:

S'assurer de ne pas faire descendre le lit lorsque des objets se trouvent sous le lit. Ne pas inspecter le dessous du lit pourrait entraîner des dommages matériels et des risques de blessures.

CAUTION

THIS BED IS SUITABLE FOR USE ONLY WITH OXYGEN ADMINISTERING EQUIPMENT OF THE NASAL OR MASK TYPE OR A TENT COVERING ONLY THE UPPER HALF (HEAD END) OF THE BED. OXYGEN TENT CANOPIES SHOULD NOT EXTEND BELOW BED SPRING LEVEL. LOCK HAND CONTROL AT FOOT OF BED WHEN USING OXYGEN ADMINISTERING EQUIPMENT.

WARNING:

Incompatible mattresses can create hazards. Read Instructions for use.

ATTENTION:

Matelas incompatibles peuvent créer des dangers. Lisez les Instructions d'utilisation.



WARNING!

DO NOT LOWER BED WHEN OBJECTS ARE BENEATH BED. FAILURE TO INSPECT UNDER BED CAN RESULT IN DAMAGE TO PROPERTY OR PERSONAL INJURY.

ATTENTION:

CE LIT PEUT ETRE UTILISE UNIQUEMENT AVEC UN EQUIPMENT DESTINE A L'ADMINISTRATION D'OXYGENE DE TYPE NASAL OU MASQUE OU AVEC UNE TENTE RECOUVRANT SEULEMENT LA MOTTIE AVENT (TETE) DU LIT. LES COTES DE LA TENTE OXYGENE NE DOIVENT PAS SE PROLONGER PLUS DAS QUE LA SOMMIER DU LIT.

CAUTION

CONNECT TO SINGLE WHITE STAFF CONTROL CABLE ONLY. POTENTIAL DAMAGE TO THE STAFF CONTROL AND/OR BED ELECTRONICS MAY RESULT FROM CONNECTING TO OTHER INCOMPATIBLE ELECTRONICS

ATTENTION

CONNECTEZ LE CÂBLE DE COMMANDE DU PERSONNEL BLANC UNIQUEMENT. DES DOMMAGES POTENTIELS AU CONTRÔLE DU PERSONNEL ET / OU À L'ÉLECTRONIQUE DU LIT PEUVENT RÉSULTER DE LA CONNEXION À D'AUTRES ÉLECTRONIQUES INCOMPATIBLES

ENVIRONMENTAL SPECIFICATIONS AND RFI INFORMATION

OPERATING CONDITIONS	
Ambient Temperature	10°C to 40°C
Relative Humidity	30% to 75% Non-Condensing
Atmospheric Pressure	700 hPa to 1060 hPa
Protected Against Splashing Water	IPX4

STORAGE AND TRANSPORT CONDITIONS	
Temperature	-10°C to 50°C
Relative Humidity	20% to 90%
Atmospheric Pressure	700 hPa to 1060 hPa

DISPOSAL OF EQUIPMENT AND ACCESSORIES



Follow local governing ordinances and recycling plans regarding disposal of the device or components normally used in operation. The device does not generate waste or residue in operation. Any accessories not part of the device **MUST** be handled in accordance with the individual product marking for disposal.

BED SETUP AND OPERATION INSTRUCTIONS

UNPACKING THE BED

- Ensure all parts/components are included.
- Check all bed components for obvious damage.
- Inspect the Power Cord for cuts or damage.
- Ensure all actuator/motor cables are routed and connected properly to the control box.

DISCARD

1. Large Block
2. Notched 2 x 4 Board
3. Honeycombed Block
4. End Caps with Foam
5. Notched Leg Foam
6. Small Cable Tie - CUT

KEEP

7. Wireform Wallsaver (7A & 7B)
8. Two Mattress Retainers
9. Hand Control Pendant Holster

NOTE:

END OF POWER CABLE IS COILED FOR SHIPPING AND TIED, WITH CABLE TIE, TO GRID WIRE WITH HAND CONTROL PENDANT, PENDANT CABLE AND HOLSTER.

CUT AND DISCARD CABLE TIE AROUND CABLES WHEN YOU UNPACK THE BED.

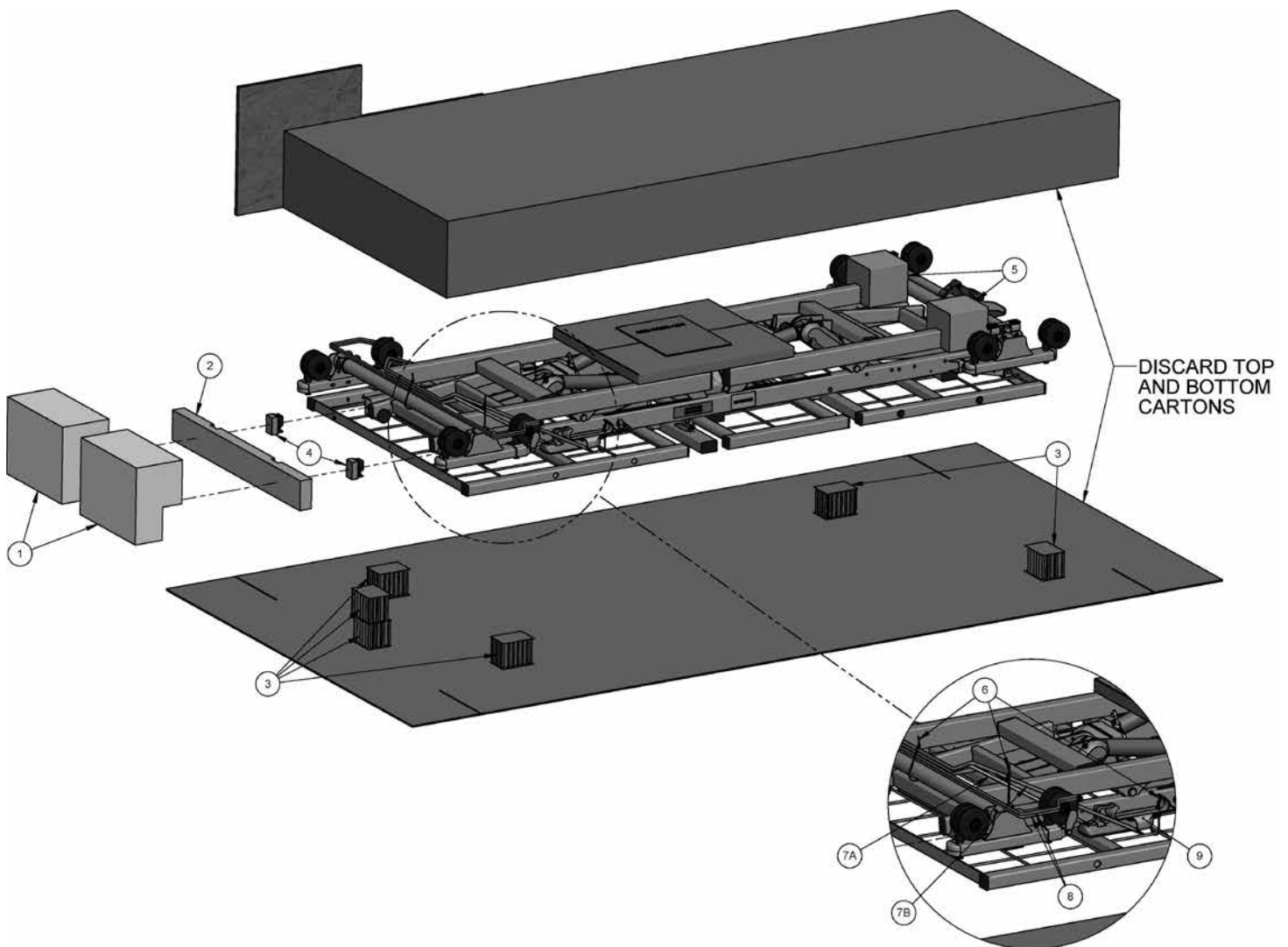

HEADBOARD AND FOOTBOARD ASSEMBLY / INSTALLATION

1. HEADBOARD INSTALLATION

- The headboard comes with four pre-installed inserts - consider this the inside of the headboard.
- Position two mounting tubes on the outside of the headboard with "L" facing inward.
- Align the mounting tube top holes with the headboard top holes.
- Insert a 40mm long socket head cap screw through each of the top holes and bottom holes and screw into each insert. Tighten with the hex key included in the kit.
- At the head deck end, slide the mounting tube "L" portions into the main frame rail hollow ends.
- **FOR 80" BEDS:** Slide the mounting tubes in until the first tube hole aligns with the first rail hole. See illustration below.
- **FOR 76" BEDS:** Slide the mounting tubes in until the first tube hole aligns with the second rail hole. See illustration below.

2. FOOTBOARD INSTALLATION

- The footboard comes with four pre-installed inserts - consider this the outside of the footboard.
- Position two mounting tubes on the inside of the footboard with "L" facing inward.
- Align the mounting tube top holes with the footboard top holes.
- Insert a 40mm long socket head cap screw through each of the top holes and bottom holes and screw into each insert. Tighten with the hex key included in the kit.
- At the foot deck end, slide the mounting tube "L" portions into the main frame rails hollow ends.
- **FOR 80" BEDS:** Slide the mounting tubes in until the first tube hole aligns with the first rail hole. See illustration below.
- **FOR 76" BEDS:** Slide the mounting tubes in until the first tube hole aligns with the second rail hole. See illustration below.

HEADBOARD

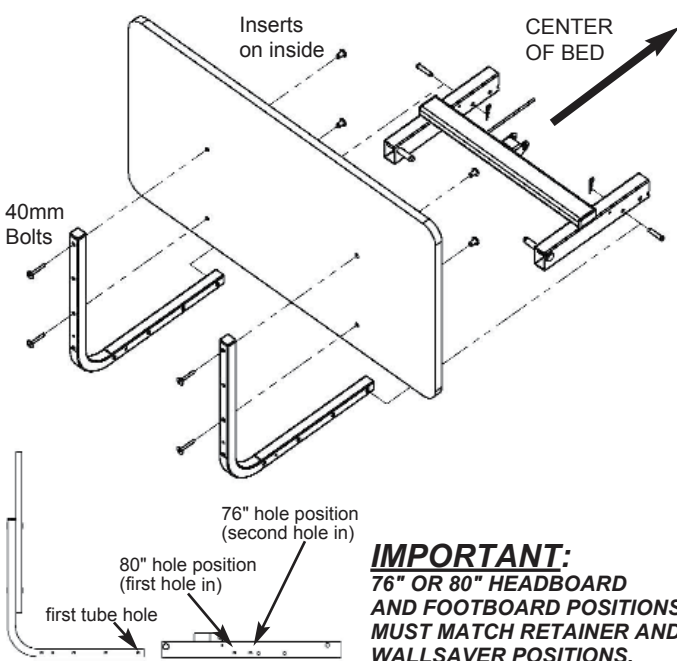

FOOTBOARD

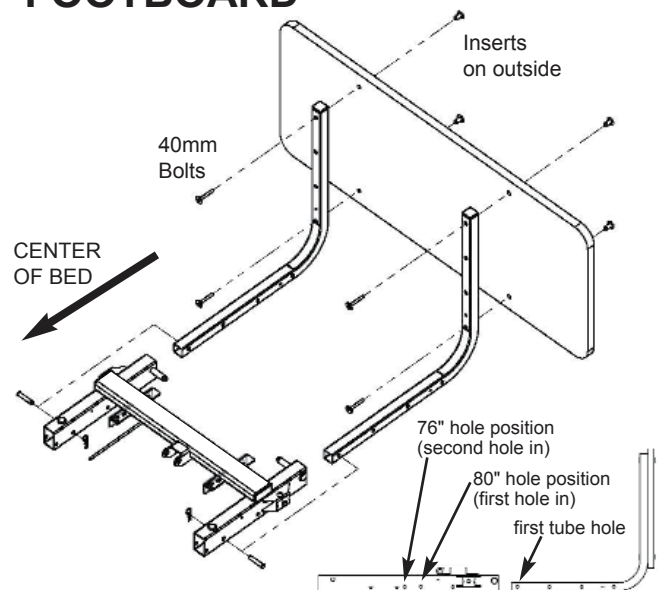

SLIDE-W-I-D-E HEADBOARD AND FOOTBOARD POSITIONS USING THE QUICK-RELEASE DETENT PINS

HEADBOARD INSTALLATION

1. The headboard has four pre-installed inserts on the inside surface.
2. Position two mounting tubes on the outside of the headboard with "L" facing inward toward center of bed. Align the mounting tube top holes with the headboard top holes.
3. Insert socket head cap screws from Panel Mounting Kit through top holes into headboard.
4. Insert a second set of socket head cap screws through third-from-top tube holes into headboard. Hand tighten only.
5. From both sides, insert the lanyard-attached detent pins through the frame holes as shown, ensuring the detent pin balls extend completely through rails.
6. At the head end, slide the mounting tube "L" portions into the main frame rail hollow ends.
 - a. FOR 80" BED LENGTH: Slide the mounting tubes in until the first tube holes align with the first rail holes as shown below.
 - b. FOR 76" BED LENGTH: Slide the mounting tubes in until the first tube holes align with the second rail holes as shown below.
7. Tighten the four screws with the hex key included in the kit.

FOOTBOARD INSTALLATION

1. The footboard has four pre-installed inserts on the outside surface.
2. Position two mounting tubes on the inside of the footboard with "L" facing inward toward center of bed. Align the mounting tube top holes with the footboard top holes.
3. Insert socket head cap screws from Panel Mounting Kit through top holes into footboard.
4. Insert a second set of socket head cap screws through fourth-from-top tube holes into footboard. Hand tighten only.
5. From both sides, insert the lanyard-attached detent pins through the frame holes as shown, ensuring the detent pin balls extend completely through rails.
6. At the foot end, slide the mounting tube "L" portions into the main frame rail hollow ends.
 - a. FOR 80" BED LENGTH: Slide the mounting tubes in until the first tube holes align with the first rail holes as shown below.
 - b. FOR 76" BED LENGTH: Slide the mounting tubes in until the first tube holes align with the second rail holes as shown below.
7. Tighten the four screws with the hex key included in the kit.



HEADBOARD

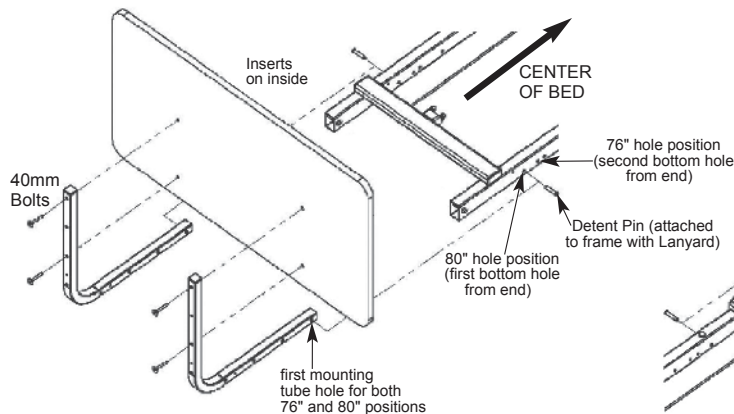

IMPORTANT:
76" OR 80" HEADBOARD AND FOOTBOARD POSITIONS MUST MATCH RETAINER AND WALLSAVER POSITIONS.

FOOTBOARD

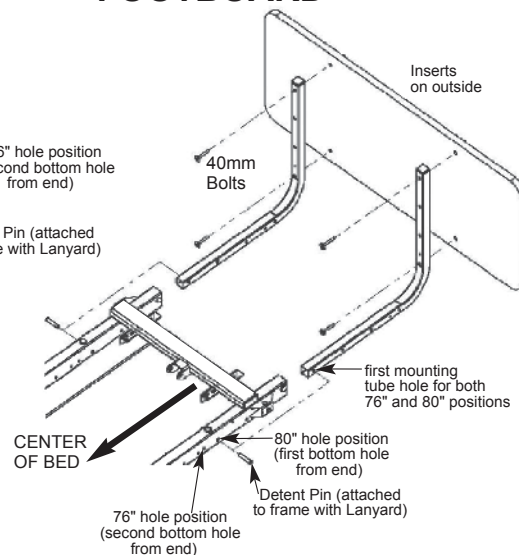

STANDARD MATTRESS RETAINER INSTALLATION (USING 2 MATTRESS RETAINERS)

1. Determine if you need to position your bed in an 80" or 76" configuration (80" outside holes; 76" inside holes - see Details A and B).
2. On the foot end, carefully squeeze the Mattress Retainer ends inward, toward the center of the retainer, and insert the ends into the proper holes (see Details A and B).
3. Lay the Mattress Retainer down so that the elbows rest on the decks and the long cross rod is on the foot end side as shown.
4. On the head end, carefully squeeze the Mattress Retainer ends inward, toward the center of the retainer, and insert the ends into the proper holes (see Details A and B).
5. Lay the Mattress Retainer down so that the elbows rest on the decks and the long cross rod is on the head end side as shown.

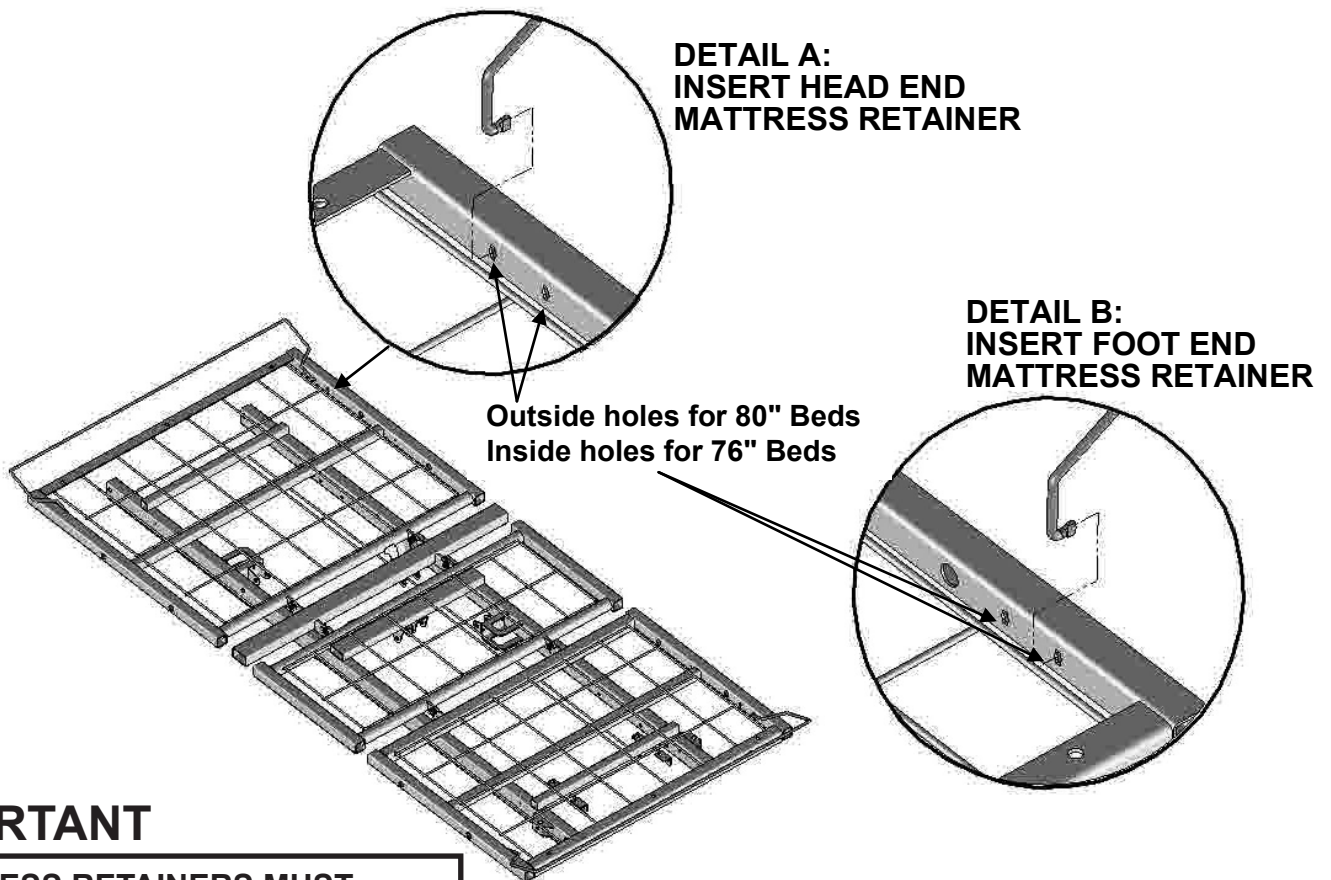

IMPORTANT

MATTRESS RETAINERS MUST MATCH HEADBOARD, FOOTBOARD, AND WALLSAVER POSITIONS.



Be sure to use a mattress that is properly sized to fit the sleep deck, which will remain centered on the deck relative to State and Federal Guidelines. Use of an improperly fitted mattress could result in injury or death.



Use a properly sized mattress in order to minimize the gap between the side of the mattress and assist devices. This gap must be small enough to prevent resident/patient from getting their head or neck caught in this location.

MATTRESS RETAINER INSTALLATION FOR OPTIONAL SLIDE-W-I-D-E DECK

1. The Slide-W-I-D-E Expandable/Retractable Sleep Deck features two sets of Mattress Retainers that are positioned at bed head and foot corners.
2. To install, position the mattress retainers above the sleep deck corners with ends perpendicular to the sleep deck surface and long crooked bent ends on outside as shown below.
3. Insert the rod ends into the appropriate 80" or 76" bed length holes as shown in detail at bottom right.
4. Once both ends are engaged, tilt each retainer toward the corner so that the retainer elbows rest on the deck.

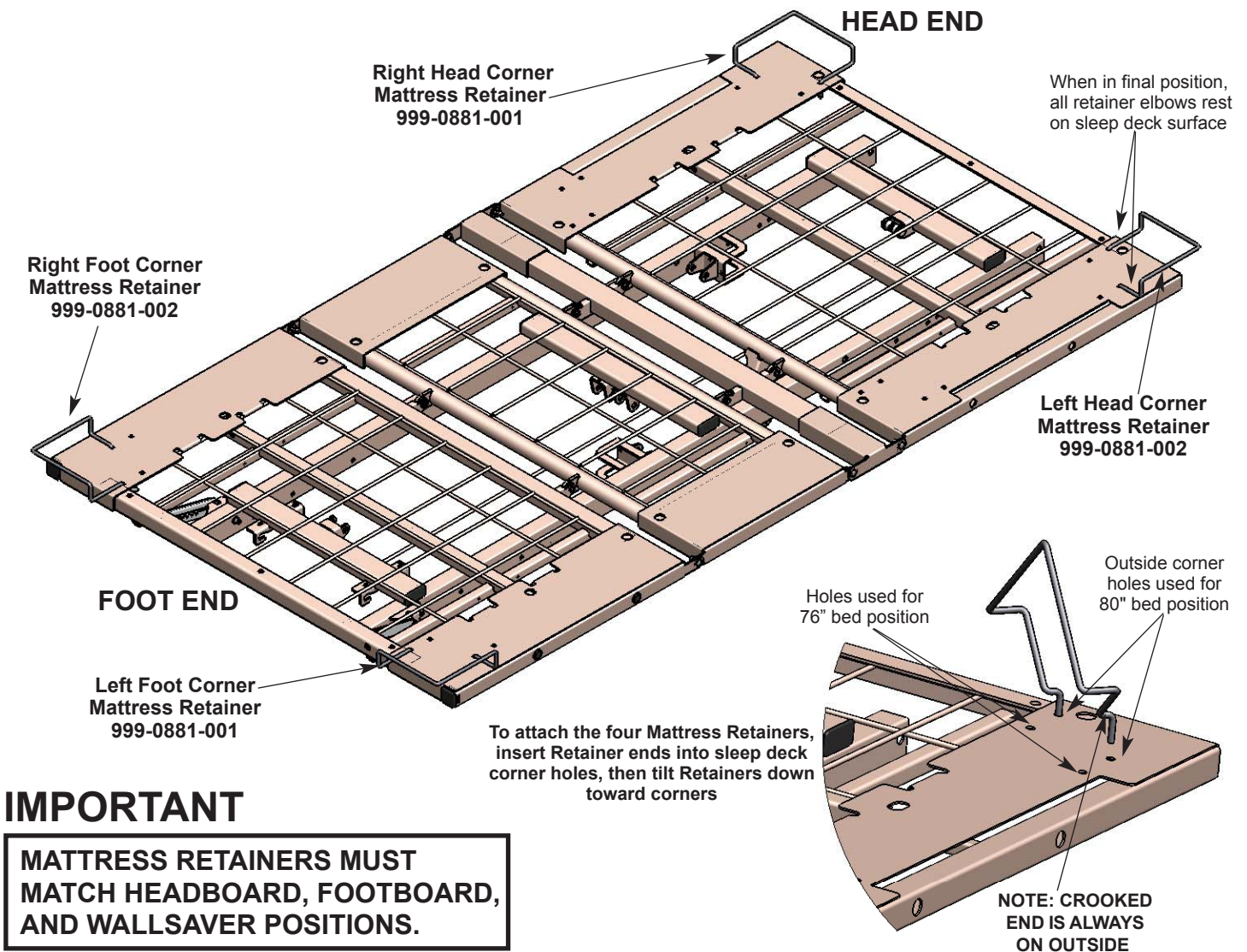

STANDARD WIREFORM WALLSAVER INSTALLATION

WALLSAVER ASSEMBLY

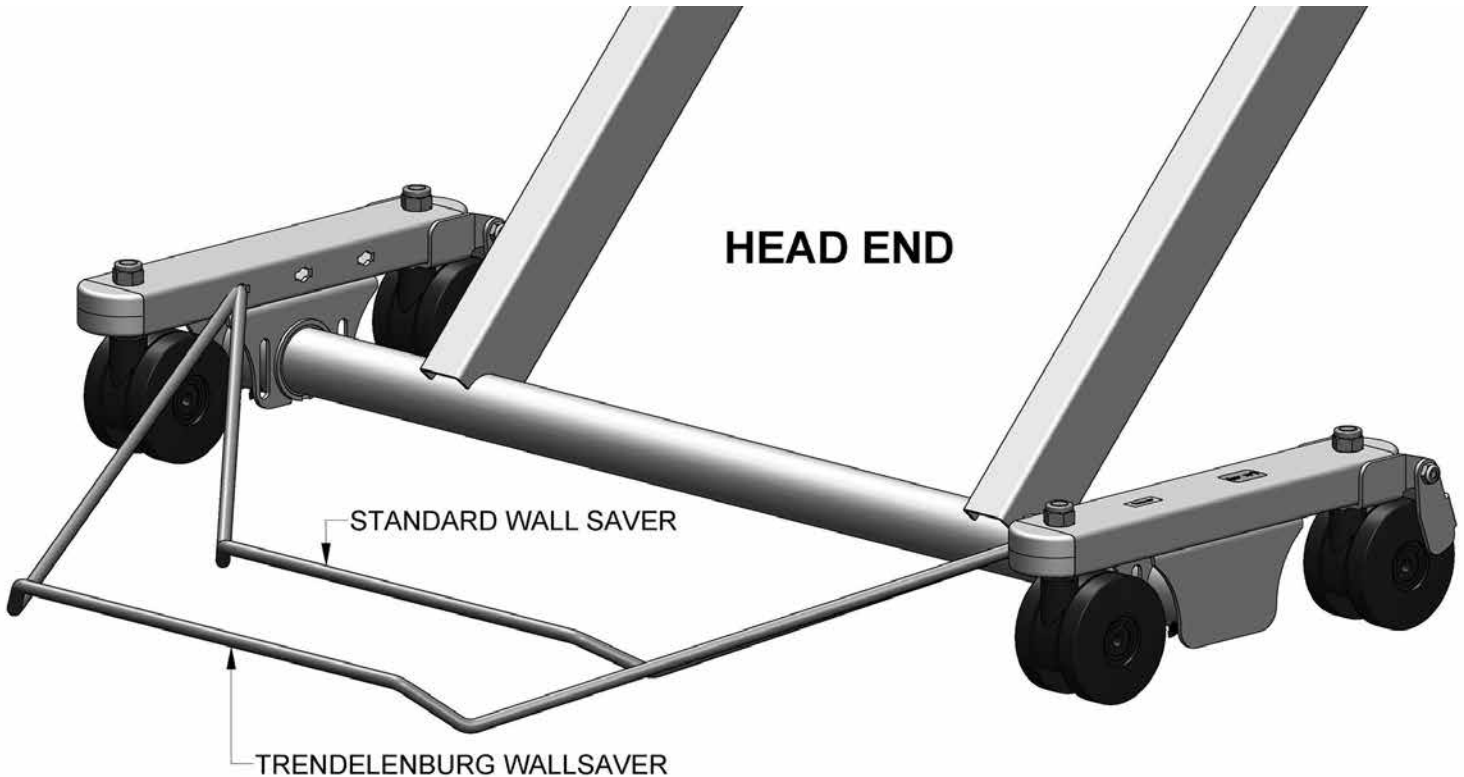

1. Position the Wireform Wallsaver ***with bent end facing upward*** and tab ends facing inward as shown above.
2. Determine the position desired (see **WALLSAVER POSITIONS** below).
3. Gently squeeze the wallsaver tab ends inward toward the center of the wallsaver and, holding the tabs parallel with the caster base slots, slide the tabs into the slots while letting the wallsaver gently expand outward.
4. Turn the wallsaver downward until it rests on the floor.

WALLSAVER REMOVAL

1. To remove or move the wallsaver to a new position, raise the wallsaver off the floor until the end tabs are horizontal.
2. Squeeze the ends toward the center of the wallsaver until the end tabs slide out of the caster base slots.

WALLSAVER POSITIONS

1. The Zenith wallsaver features two standard positions for easy bed/mattress length reconfigurations - 76" and 80".
2. For 76" beds, position the wallsaver ends in the BACK caster base slots (toward the foot end). For 76" beds using an optional Trapeze unit, position the wallsaver ends in the FRONT caster base slots (toward the head end.)
3. For 80" beds, position the wallsaver ends in the FRONT caster base slots (toward the head end).

OPERATING THE OPTIONAL CASTER PEDAL LOCK MECHANISM

LOCKED POSITION

To lock the foot end casters, step on the red pedal until the caster lock engages.

UNLOCKED POSITION

To unlock the foot end casters, step on the green release pedal until the caster lock disengages.

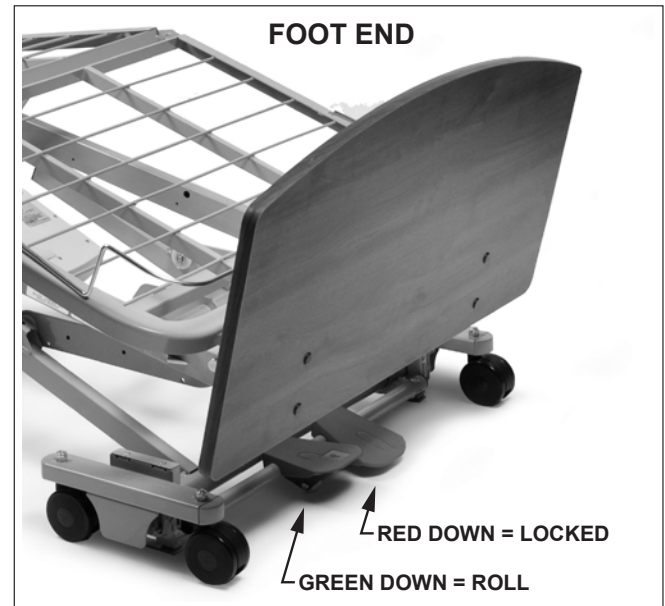

FOOT END of Zenith Series Bed
Shown with Pedal Lock Engaged
(RED DOWN = LOCKED POSITION)

PLUGGING IN THE FOOTBOARD STAFF CONTROL

STEP 1 - ATTACHING THE FOOTBOARD

The Zenith series bed features a footboard Staff Control; however, the footboard is ordered separately with your bed because of the variety of board styles available. If ordered at the same time as the bed, the Staff Control Assembly and Shroud Cover will be pre-installed to the Footboard at the factory.

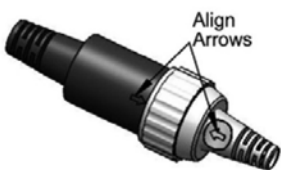

DETAIL A:
Ensure lock end caps are screwed on securely

Improper Connection
(not completely seated)

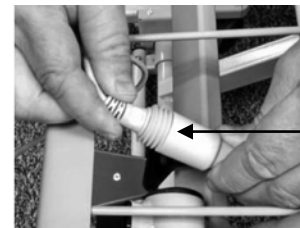

Proper Connection
(completely seated)



STEP 2 - CONNECTING THE CABLES: REFER TO DETAIL A ABOVE





WARNING: CONNECT TO SINGLE WHITE STAFF CONTROL CABLE ONLY. POTENTIAL INJURY OR DAMAGE TO THE STAFF CONTROL AND / OR BED ELECTRONICS MAY RESULT FROM CONNECTING TO OTHER INCOMPATIBLE ELECTRONICS.

- Insert the T-Cable end (extending out the foot end with phone jack) into the round plug, making sure the phone jack is seated correctly inside the female plug (arrow to arrow – see DETAIL A and photos above).
- Screw on the round lock cap onto the Staff Control female plug to secure (See DETAIL A).

ZENITH SERIES OPTIONAL ACCESSORIES
ZENITH 7100 / 9100 SERIES OPTIONAL ACCESSORIES



Pivot Assist Bar	Fixed Assist Bar
	
ZA90300	ZA85000



Counter-Rotating Assist (set of 2)	Board-Mounted Hand Control Pendant Holster
	
ZA84200	ZA9150

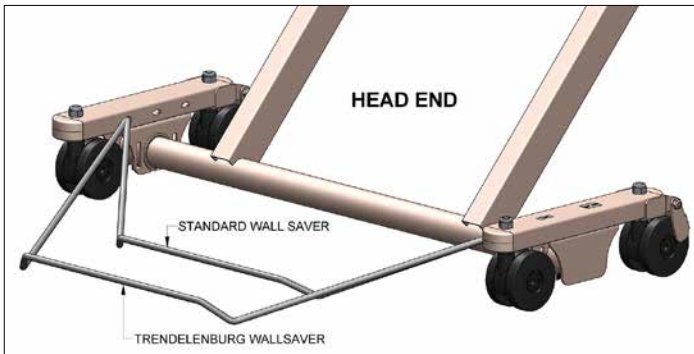
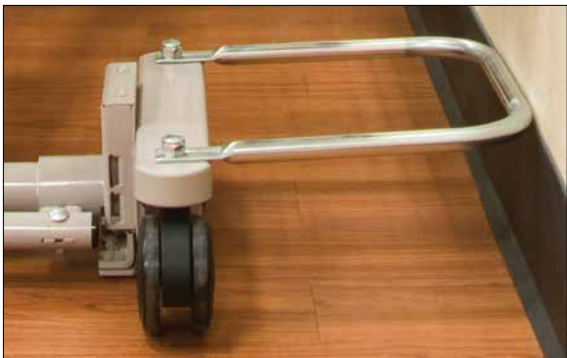

Bed Length Extension Kit (extends 35", 42", and Slide-W-I-D-E Deck)

4-inch Length Extension Kit :ZA90500
8-inch Length Extension Kit: ZA90400



<p>Trapeze Adapter Kit</p>	<p>Trapeze</p>
	
<p>ZA79000</p>	<p>ZA78100</p>

<p>Long (Trendelenburg) WallSaver</p>	<p>Side-WallSaver Bumper (set of 2)</p>
	
<p>ZA90070</p>	<p>ZA86200 (35") ZA89200 (42")</p>

<p>Plastic Pan Deck Kit</p>	<p>Backup Battery & Battery Charger</p>
	
<p>ZA87500</p>	<p>Backup Battery: 999-0831-003 Battery Charger: 999-0711-002</p>

<p>USB Phone Charger-Power Supply Kit</p>	<p>Under-Bed-Light Kit (must be used with Staff Control and/or APS Hand Control Pendant)</p>
	
<p>ZA90020</p>	<p>ZA90010</p>

<p>Advanced Positioning Backlit Hand Control Pendant with Trendelenburg / Reverse Trendelenburg</p>	<p>Advanced Positioning Backlit Hand Control Pendant with Chair Position only</p>
	
<p>ZA83106</p>	<p>999-0806-301SP</p>

<p>1-Person Bed Transport Dolly (set)</p>		<p>Board-Mounted IV Socket Kit</p>
		
<p>ZA89900 unassembled</p>	<p>ZA89900 assembled with bed</p>	<p>ZA19000</p>

OPERATION OF OPTIONAL SLIDE-W-I-D-E 35" - 39" - 42" EXPANDABLE / RETRACTABLE SLEEP DECK

IMPORTANT SAFETY AND WARNING INFORMATION



WARNING: Read and follow all instructions. Care must be taken when adjusting your Slide-W-I-D-E Expandable/Retractable Sleep Deck. To avoid possible injury, keep hands clear of deck ends when expanding or retracting, especially near the headboard or footboard. To avoid pinching, the deck should *only* be adjusted from the side. Assist devices and mattress should be removed prior to adjusting the deck.



WARNING: When expanding or retracting the deck, make sure to first remove the quick-release detent pins located on the underside of both sides of the foot deck and head deck. Make sure to re-insert the pins into the proper width holes before allowing patient into the bed to avoid injury to the patient and damage to the decks. Pins must be fully seated before any operation of the bed.



WARNING: Caregivers should be aware that the corners of the deck system may extend slightly past the headboard and footboard at the corners. Care should be taken to avoid these areas when moving around the bed.



WARNING: Patient body weight should be evenly distributed over the sleeping surface of the bed. **DO NOT** allow the patient to lie, sit, or lean in such a way that their entire body weight is placed only on the raised head or foot section, or only one side of the bed. This especially applies when repositioning or transferring a patient in or out of the bed. Increased risk may occur when the patient's size and/or weight are inappropriate for the bed's dimensions or weight capacity.

FEATURES

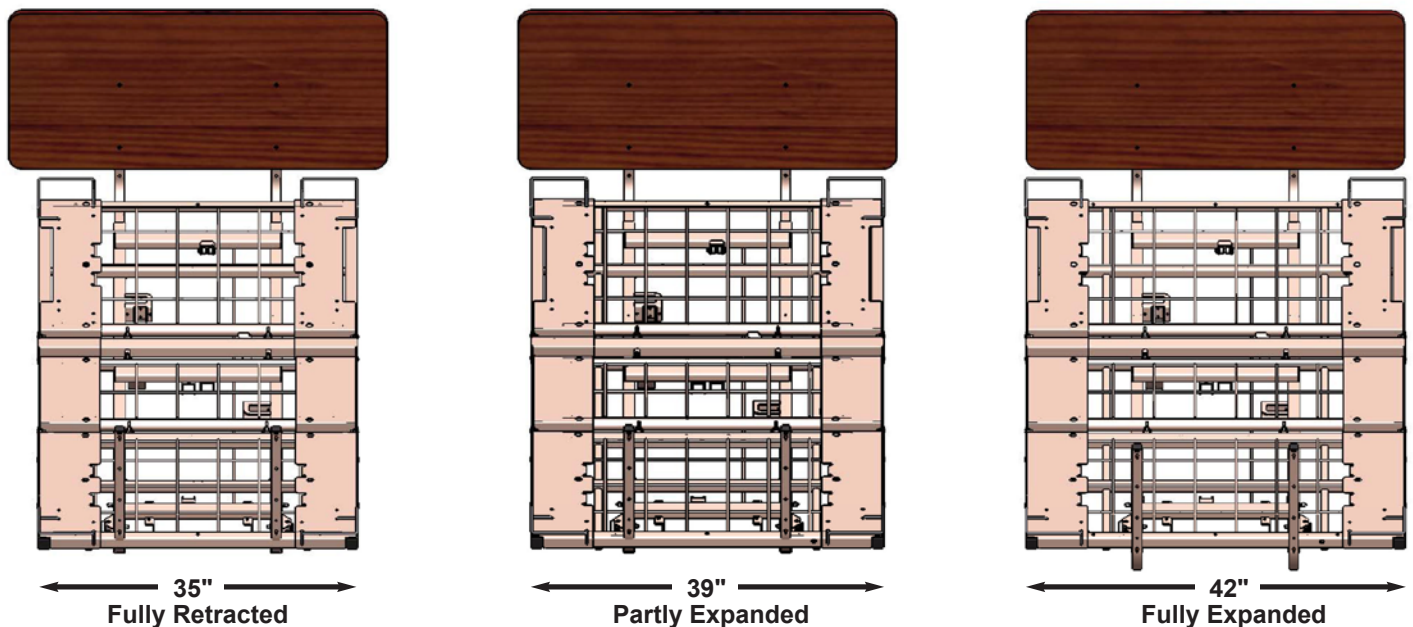

- Expandable/Retractable deck quickly and easily adjusts to 35", 39", and 42" with two quick-release ball-detent pins on each side.
- Quick adjustment is ideal for moving through narrow doorways.
- All pins are attached to the bed with lanyards, eliminating lost parts.
- Wide headboards and footboards are available in both 39" and 42" widths (both sold separately).
- Rails and assist devices feature quick-release systems - no tools are required for assembly of these devices.

SLIDE-W-I-D-E SLEEP DECK POSITIONING

1. The Slide-W-I-D-E Expandable/Retractable Sleep Deck can be set to one of three widths:
Fully Retracted = 35"; Partly Expanded = 39"; and Fully Expanded = 42".
2. To adjust the deck position, first remove all four quick-release detent pins from the underside of both Head and Foot Decks by pulling out the pins by the small rings. Each detent pin is attached to a lanyard which is connected to a screw on the underside of the deck to prevent misplacement (see illustrations below).

Labels on deck sides indicate locations of 4 removable detent pins

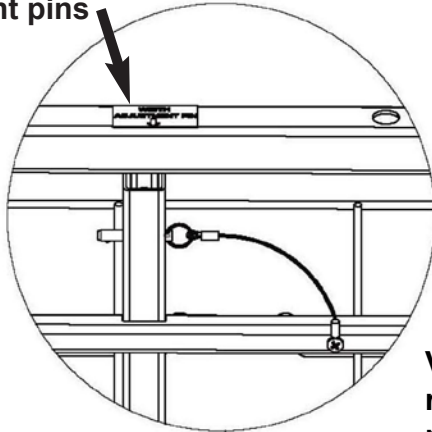

3. Stand at the side of the bed and place your hands near the detent pin labels (your hands must be this widely spaced) and hold the entire left or right side of the expandable deck (not the ends). Pull the deck out toward you to expand, or push the deck inward toward center to retract. On the underside, align the desired hole position on the deck insert tubes with the single hole in the end of the mainframe cross tubes (see below).
4. **IMPORTANT:** Reinsert the detent pin in all four locations (A - D), ensuring the ball at the end of the detent pin extends through the other side of all four mainframe position holes.

View of underside of bed is shown below for reference only. Sleep deck positioning is performed while bed is upright.

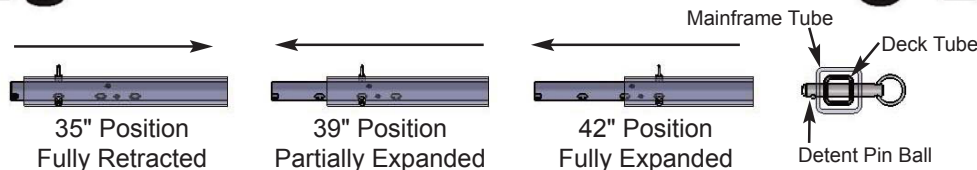
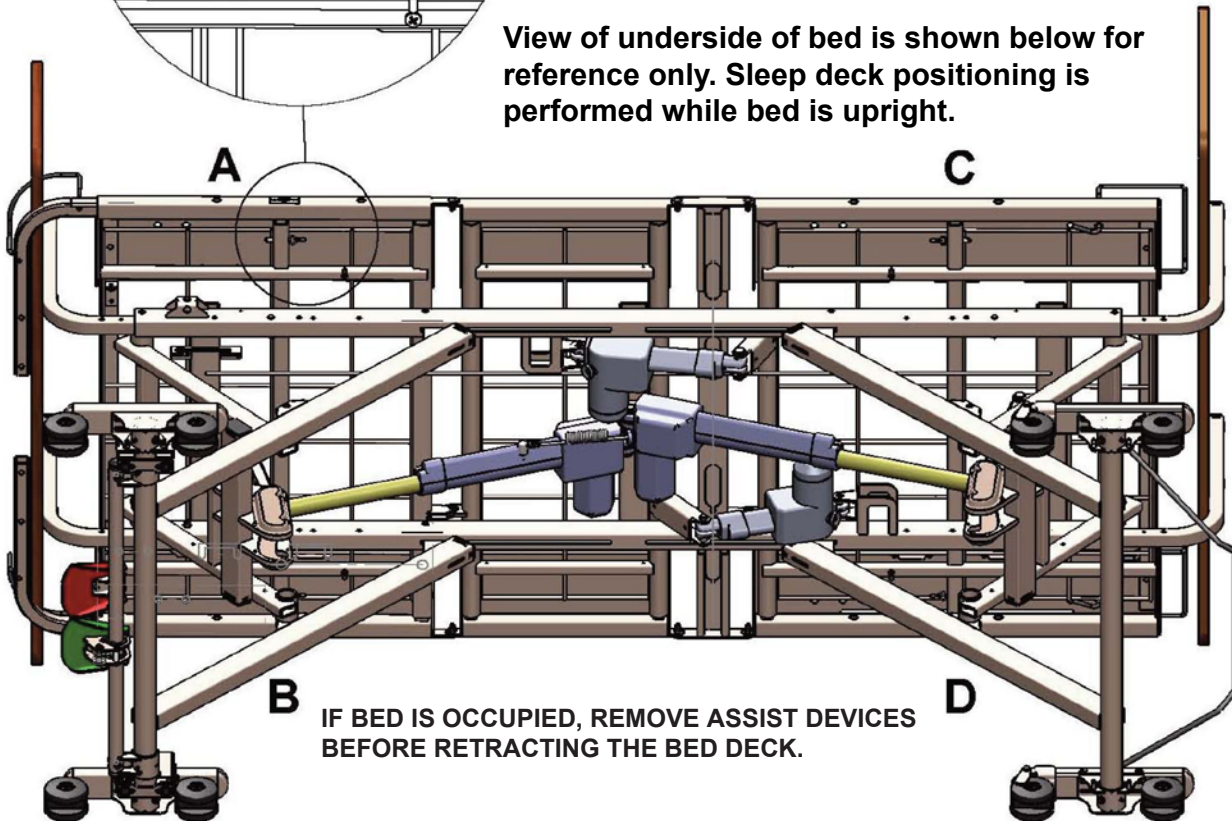

BED OPERATION

ZENITH SERIES HAND CONTROL PENDANT OPERATION

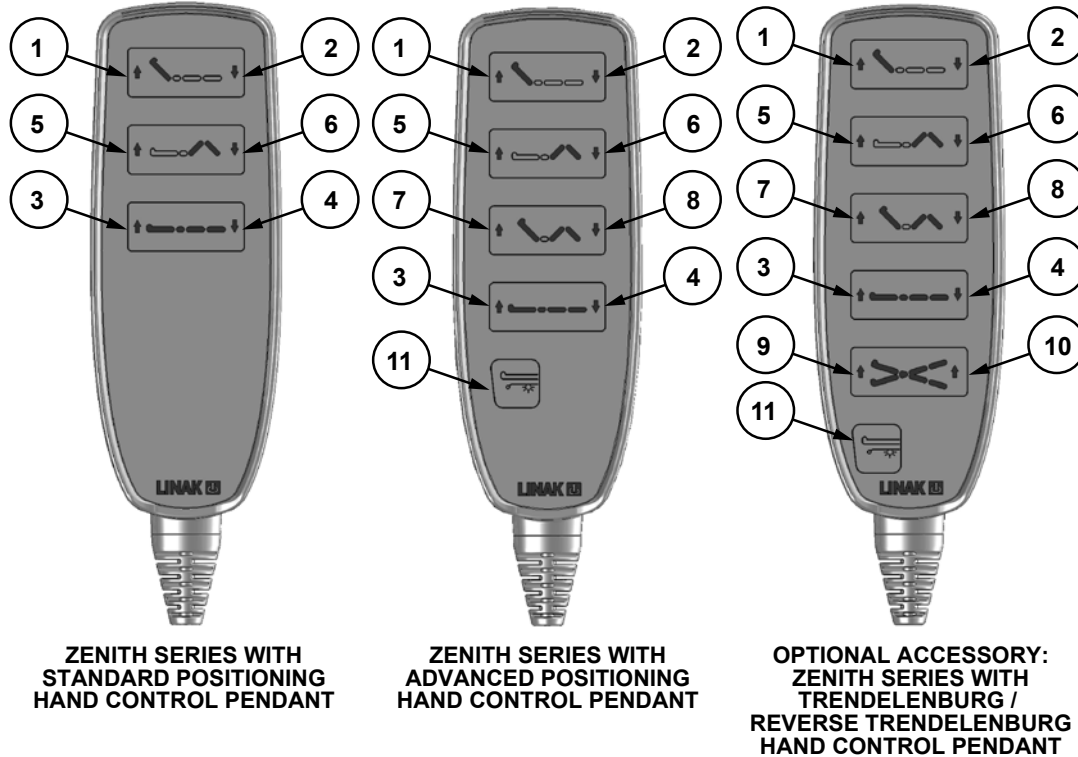

HAND CONTROL PENDANT OPERATION	
BUTTON	FUNCTION
1	HEAD DECK ANGLE UP
2	HEAD DECK ANGLE DOWN
3	HI/LO UP (RAISE ENTIRE BED)
4	HI/LO DOWN (LOWER ENTIRE BED)
5	KNEE AND FOOT DECK ANGLE UP
6	KNEE AND FOOT DECK ANGLE DOWN
7	SET TO CHAIR POSITION
8	UNDO CHAIR POSITION
9	REVERSE TRENDELENBURG POSITION
10	TRENDELENBURG POSITION
11	OPTIONAL UNDERBED LIGHT

NOTE:

The Zenith Series Hand Control Pendant can be plugged into the T-cable plugs on either side of the bed for easy access. The opposite side of the T-Cable should always have the provided cap attached for safety.

The two vertical ends of the double T-Cable run toward the foot end of the bed, with one vertical end plugging directly into the control box (or optional Underbed Light if your bed has that feature) and the other longer end runs along the tie rod and extends out the foot end and plugs into the Staff Control cable.

BED OPERATION - OPTIONAL STAFF CONTROL PANEL *

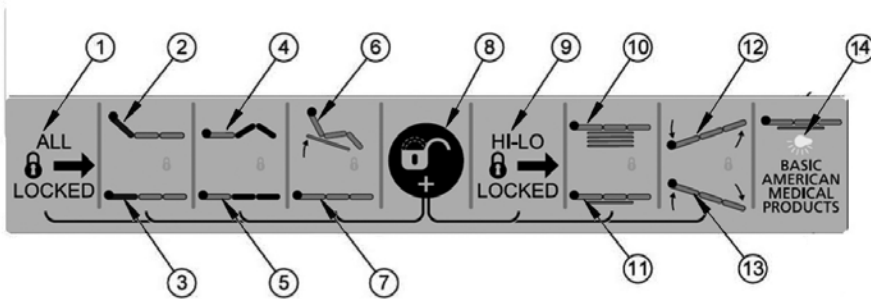

Press "Underbed Light" button (#14) to turn underbed light on or off.

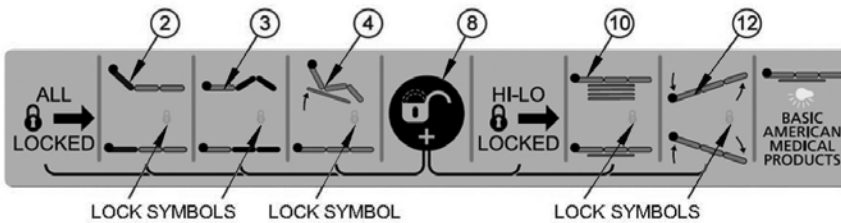

Press "Head", "Knee", or "Chair" and "Key" at the same time to unlock individual lock out functions.

Press "HI/LO Locked" to lock out "HI/LO", "Trendelenburg", and "Reverse Trendelenburg" functions.

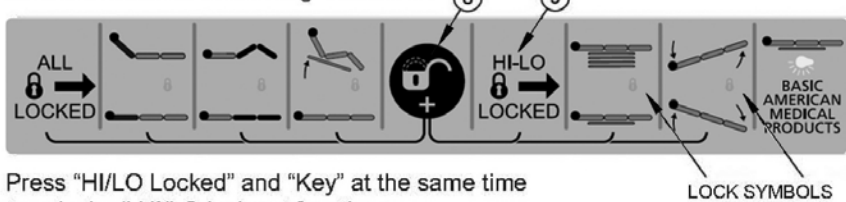

Press "HI/LO Locked" and "Key" at the same time to unlock all HI/LO lock out functions.

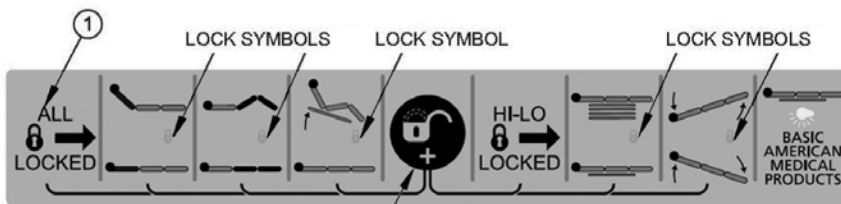

Press "All Locked" and "Key" at the same time to unlock all functions.

1	ALL LOCKED BUTTON
2	HEAD DECK UP BUTTON
3	HEAD DECK DOWN BUTTON
4	KNEE & FOOT DECK UP BUTTON
5	KNEE & FOOT DECK DOWN BUTTON
6	CHAIR POSITION BUTTON
7	UNDO CHAIR POSITION BUTTON
8	KEY LOCK/UNLOCK BUTTON
9	HI/LO (T/TR) LOCKED BUTTON
10	HI/LO UP BUTTON
11	HI/LO DOWN BUTTON
12	TRENDELENBURG
13	REVERSE TRENDELENBURG
14	UNDERBED LIGHT BUTTON

LOCK OUT SINGLE FUNCTIONS

To individually lock out the "Head", "Knee", "Chair", and "HI/LO" functions, press the appropriate top icon (#2, 3, 4, 10, or 12) button and the "Key" button at the same time. An orange LED lock symbol will appear under the related icon.

To "Unlock" any of the individual functions, press the top icon (#2, 3, 4, 10, or 12) and the "Key" button (#8) simultaneously. LED lights will not show up.

LOCK OUT HI/LO FUNCTIONS

To lock out the functions for raising and lowering the entire bed and tilting the bed for Trendelenburg positions, press the "HI/LO Locked" (#9) button. Orange LED lock symbols will appear under the HI/LO and Trendelenburg icons.

To "Unlock" all HI/LO functions, press the "HI/LO Locked" button (#9) and the "Key" button (#8) simultaneously. Orange LED lights will not show up.

LOCK OUT EVERYTHING

To lock out all functions, press the "All Locked" button (#1). Orange LED lock symbols will appear under the "Head", "Knee", "Chair", "HI/LO", and "Trendelenburg/Reverse Trendelenburg" icons.

To "Unlock" all functions, press the "All Locked" button (#1) and the "Key" button (#8) simultaneously. Orange LED lights will not show up.



* **Staff Control with Advanced Positioning functions is shown above. Staff Control with Standard Positioning functions is shown at left; all standard functions operate the same as those defined above.**

BED OPERATION - CHAIR POSITION

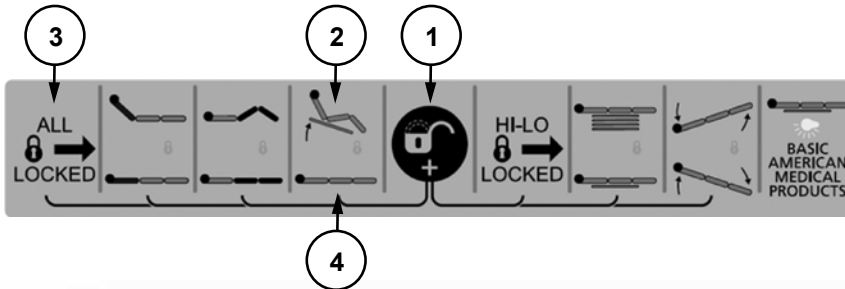

1. Ensure the Chair position on the Staff Control panel is not locked out (*orange lock icon*). To unlock, press Lock icon button #1 and Chair icon button #2 (or "All Locked" button #3) simultaneously.

2. To move the bed to Chair position (*foot and knee decks angled up, head deck angled up, and head of bed tilted up*), press Chair icon button #2.

To release the chair feature and return the bed to horizontal position, press Flat Bar icon #4.



The Chair feature can also be operated using the Hand Control Pendant.



ZENITH SERIES WITH
ADVANCED POSITIONING
HAND CONTROL PENDANT

OPTIONAL ACCESSORY:
ZENITH SERIES WITH TRENDLENBURG /
REVERSE TRENDLENBURG
HAND CONTROL PENDANT

BED OPERATION - TRENDELENBURG / REVERSE TRENDELENBURG POSITION

1. Ensure the Staff Control HI/LO function is not locked out (*orange lock icon*). To unlock, simultaneously press Key 1 and HI/LO Locked button 2.
2. To move the bed to Trendelenburg position (foot end up), press button 3.
3. To move the bed to Reverse Trendelenburg position (head end up), press button 4.

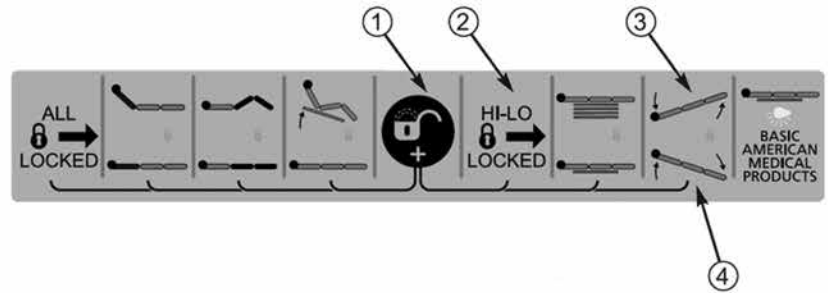

ZENITH SERIES ELECTRICAL CABLING

- ❶ POWER CORD
- ❷ T-CABLE
- ❸ HEAD CABLE
- ❹ FOOT CABLE
- ❺ HI/LO CABLE (FOOT)
- ❻ HI/LO CABLE (HEAD)
- ❼ BATTERY BACKUP CABLE
(Zenith 9000 with APS only)
- ❽ GROUND WIRE

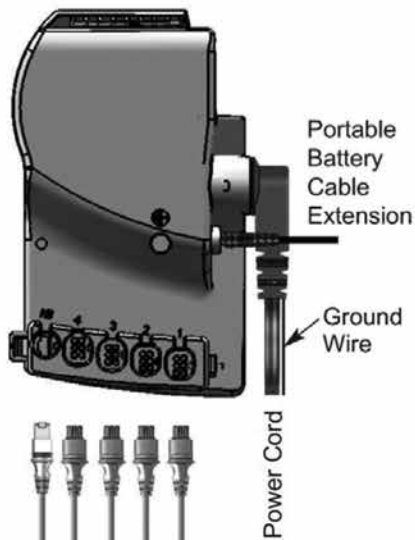

T-Cable (HB)
 HI/LO (Ft) - Port 4
 Foot - Port 3
 HI/LO (Hd) - Port 2
 Head - Port 1

Power Cord and
 Battery Cable -
 Side of Control Box

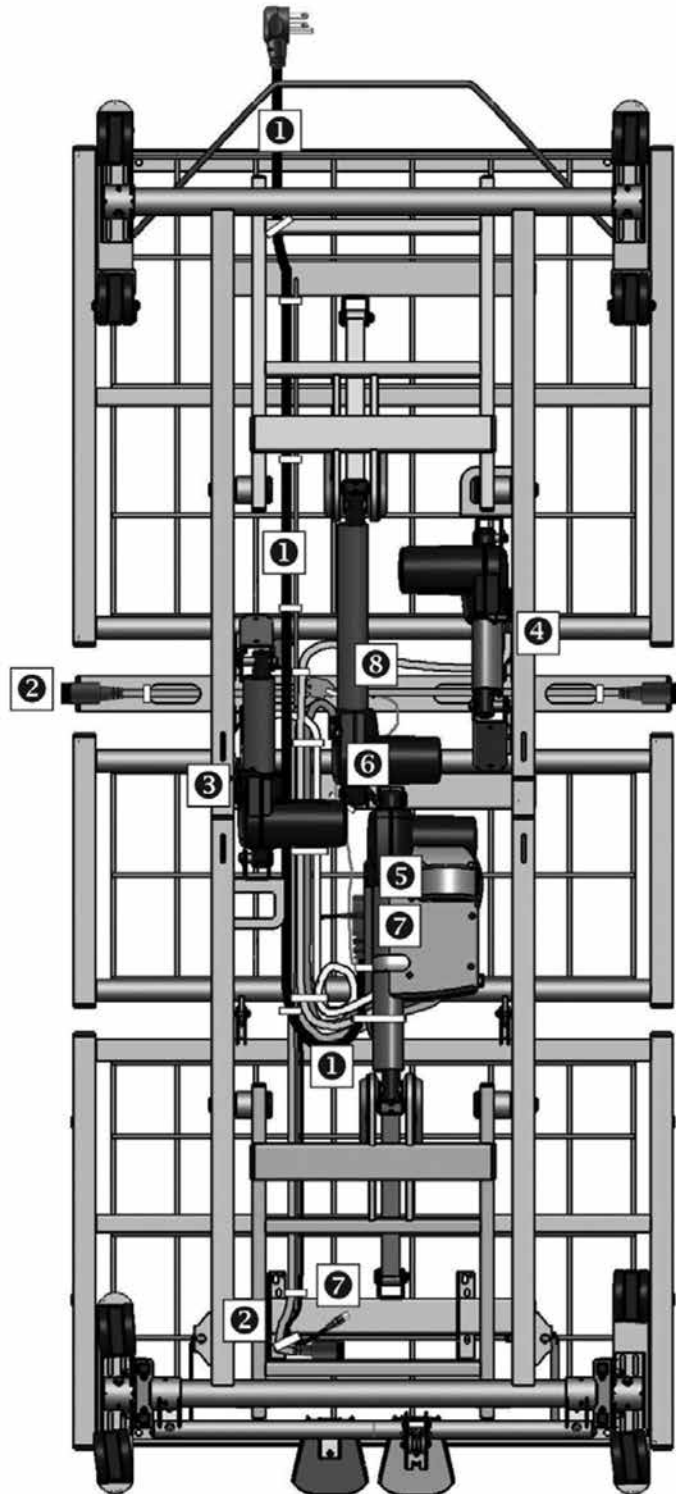

TROUBLESHOOTING

NOTHING WORKS — NO POWER

1. Verify the outlet is supplying power.
2. Ensure the power cord is not pinched, frayed, or damaged in any way. Replace the Power Cord if damaged.
3. Ensure all power cord, T-Cable, Hand Control Pendant, and Control Box receptacles and plugs are seated and fully inserted.
4. Ensure the Staff Control does not have functions locked out.
5. Plug the Hand Control Pendant directly into the Control Box. If the bed works, replace the T-Cable.
6. Replace the Hand Control Pendant with a known good operating Pendant. If the bed works, replace the Hand Control Pendant.
7. If the bed still isn't functional after steps 1-6, replace the Control Box.
8. New Control Box installation will require motor Initialization.

NOTE: Service Control Box Motor Initialization Procedure as well as detailed troubleshooting and service instruction can be found at www.grahamfield.com.

AUDIBLE SYSTEM WARNING (INTERMITTENT BEEP)

NOTE: A function that is faulty or has lost motor position will cause the Control Box to beep intermittently when the faulty function's Hand Control Pendant button is depressed. All buttons depressed after the error function will also be non-functional and will cause a Control Box beep. If equipped with a Staff Control, the staff icons will also flash to indicate a system error.

When the Audible Beeping Error signal is heard:

1. On the Hand Control Pendant, simultaneously press and hold both the **HI/LO UP** and **HI/LO DOWN** buttons (the Control Box should start beeping) for approximately five seconds until beeping stops.
2. Reinitialize the motors by lowering the bed completely. In the following order, press the Hand Control Pendant buttons until the motors stop:
 - a. **HI/LO DOWN**
 - b. **HEAD DECK ANGLE DOWN**
 - c. **KNEE AND FOOT DECK ANGLE DOWN**
3. This lowering of the motors will reset the system and should resolve minor synchronization or position lost issues. Check the bed functionality.
4. If an audible error beep occurs during reset lowering of a function or while checking functionality, the function that initiated the beep is faulty.
5. After the faulty function initiates the beep, all other button functions will cause a beep and become non-functional.
6. To operate and use the other good functions, perform step 1 again to reset the system.
7. Reinitialize the motors as in Step 2 but only lower the motors that did not initiate the audible error beep.
8. These functions will operate normally until the faulty function button is pressed again.

NOTE: If the issue is not resolved, go to www.grahamfield.com for more detailed troubleshooting and service instructions.

KNEE DOESN'T LOWER, AUDIBLE SOLID BEEP WARNING

NOTE: As a result of the bed's programmed capability to achieve APS positioning, the Knee Motor will not lower if the HI/LO motors are not level. This is a safety measure to prevent the patient from sliding out of bed while in Chair Position.

The control box will emit a solid beep warning when attempting to lower the knee if this condition is present.

NOTE: This condition can also happen with beds not equipped with APS positioning or if the frame appears to be visually level.

If the solid beep is present when trying to lower the knee:

1. Return the bed frame to a level position by pressing the Hand Control Pendant **UNDO CHAIR** button until the bed is level. Continue holding the button down until the knee retracts.
2. If not equipped with chair function, or if step 1 did not resolve the issue, lower the bed completely: press the **HI/LO DOWN** button until the motors shut off.
3. Now lower the knee using the **KNEE AND FOOT DECK ANGLE DOWN** button.

NOTE: If the issue is not resolved, go to www.grahamfield.com for more detailed troubleshooting and service instructions.

GENERAL TROUBLESHOOTING QUICK REFERENCE

NOTE: Advanced Service Troubleshooting Procedures, Flow Charts and Service Components can be found at www.grahamfield.com.

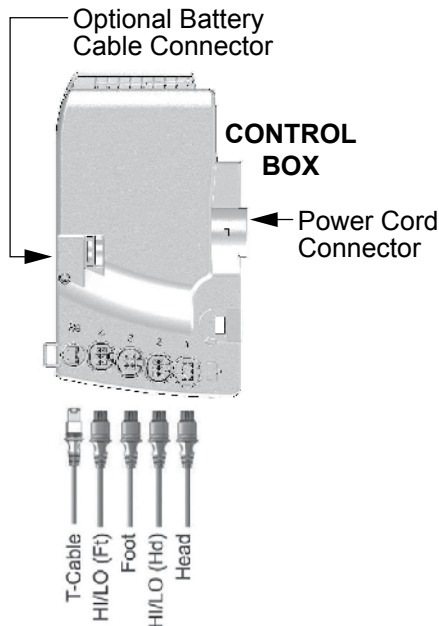

Plugs and Receptacles:

Loose plug connections or incorrect plug positioning will result in erroneous or no system error signals and faulty operation.

Before troubleshooting, ensure all plugs are engaged fully in their receptacles and located in the correct ports.



Motors

Test any motor by plugging it into a known good Control Box port.

Example: If the head motor is not functioning and the knee motor is functional, plug the

head motor into the knee Control Box port and operate the head motor with the knee Pendant button. If the head motor operates, it is good. If not working in the good port, replace the head motor or motor cable.

Motor Cables

Motor cables are interchangeable. Test a motor cable by attaching it to a known good motor and known good Control Box port and operating it.

T-Cables

Test a T-Cable by unplugging it from the Control Box port and plugging the Hand Control Pendant directly into the Control Box. If the bed functions with the Hand Control Pendant, replace the T-Cable.

Hand Control Pendants

Test a Hand Control Pendant by replacing it with a known good Pendant. If the Bed now operates, replace the Hand Control Pendant.

Staff Controls

Test a Staff Control by replacing it with a known good Staff Control. If the Bed now operates, replace the Staff Control.

Control Box

Test a Control Box by replacing it with a known good Control Box. If the bed now operates, replace the Control Box. If a known good Control Box is not available, go to www.grahamfield.com for detailed Troubleshooting Procedures.

LIMITED WARRANTY

SCOPE OF WARRANTY

GF Health Products, Inc. (“GF”) warrants to the original purchaser only that it will replace or repair components, at GF’s sole discretion, that are defective in material or workmanship under normal use and service. All warranties are conditioned upon the proper use of the products strictly in accordance with good commercial practice and applicable GF instructions and manuals, including proper use and maintenance. To the extent that a component is warranted by a third party, GF conveys all of its rights under that warranty to the original purchaser, to the extent permitted.

This limited warranty shall only apply to defects that are reported to GF’s customer service team within the applicable warranty period and which, upon examination by GF or its authorized representative, prove to be a warranty item. This limited warranty is not transferable.

The warranted components and time period are set forth below:

Main Frame and welds:	fifteen years
Control Box and Actuator Motors:	five years
Hand Control Pendant, Staff Control, and Cabling	three years
Headboard and Footboard	one year
All other durable components not listed above:	two years
Subsequent service parts under warranty until the original warranty set forth above expires, or for one year, whichever is greater.	

The applicable warranty period shall commence from date of shipment to the original customer, unless there is an expiration date on the component in which case the warranty shall expire on the earlier of warranty period or the expiration date.

OBTAINING WARRANTY SERVICE

A GF Customer Service Representative must authorize warranty service. Please contact the GF Customer Service department by calling 1-770-368-4700, sending a fax request to 1-770-368-2386 or by e-mailing a request to cs@grahamfield.com. Specific directions will be provided by the Customer Service Representative. Failure to abide by the specific directions will result in denial of the warranty claim.

EXCLUSIONS

The warranty does not cover and GF shall not be liable for the following:

- 1) Defects, damage, or other conditions caused, in whole or in part, by misuse, abuse, negligence, alteration, accident, freight damage, tampering or failure to seek and obtain repair or replacement in a timely manner;
- 2) Products which are not installed, used, or properly cleaned and maintained as required in the official manual for the applicable product;
- 3) Products considered to be of a non-durable nature including, but not limited to: casters, filters, fuses, gaskets, lubricants, and charts;
- 4) Accessories or parts not provided by GF;
- 5) Charges by anyone for adjustments, repairs, replacement parts, installation or other work performed upon or in connection with such products which are not expressly authorized in writing, in advance, by GF;
- 6) Any labor or shipping charges incurred in the replacement part installation or repair;
- 7) Costs and expenses of regular maintenance and cleaning; and
- 8) Representations and warranties made by any person or entity other than GF.

ENTIRE WARRANTY, EXCLUSIVE REMEDY AND CONSEQUENTIAL DAMAGES DISCLAIMER

THIS WARRANTY IS GF'S ONLY WARRANTY AND IS IN LIEU OF ALL OTHER WARRANTIES, EXPRESS OR IMPLIED. GF MAKES NO IMPLIED WARRANTIES OF ANY KIND INCLUDING ANY IMPLIED WARRANTIES OF MERCHANTABILITY OR FITNESS FOR A PARTICULAR PURPOSE.

IF ANY MODEL OR SAMPLE WAS SHOWN TO THE CUSTOMER, SUCH MODEL OR SAMPLE WAS USED MERELY TO ILLUSTRATE THE GENERAL TYPE AND QUALITY OF THE PRODUCT AND NOT TO REPRESENT THAT THE PRODUCT WOULD NECESSARILY CONFORM TO THE MODEL OR SAMPLE IN ALL RESPECTS.

THIS WARRANTY IS LIMITED TO THE REPAIR OR REPLACEMENT OF THE DEFECTIVE PARTS. GF SHALL NOT BE LIABLE FOR AND HEREBY DISCLAIMS ANY DIRECT, SPECIAL, INDIRECT, INCIDENTAL, EXEMPLARY OR CONSEQUENTIAL DAMAGES, INCLUDING, BUT NOT LIMITED TO: DAMAGES FOR LOSS OF PROFITS OR INCOME, LOSS OF USE, DOWNTIME, COVER, OR EMPLOYEE OR INDEPENDENT CONTRACTOR WAGES, PAYMENTS AND BENEFITS.

The warranties contained herein contain all the representations and warranties with respect to the subject matter of this document, and supersede all prior negotiations, agreements and understandings with respect thereto. The recipient of this document hereby acknowledges and represents that it has not relied on any representation, assertion, guarantee, warranty, collateral contract or other assurance, except those set out in this document.

For additional information on this product or this warranty, contact a GF Customer Service Representative.

NOTES:

- 1) Additional terms and conditions may apply.
- 2) Freight claims must be notated on the appropriate shipping documents and must be made with immediacy. International, federal and state regulations govern specific requirements for freight claims. Failure to abide by those regulations may result in a denial of the freight claim. GF will assist you in filing the freight claim.
- 3) Claims for any short shipment must be made within three (3) days of the invoice date.

GF Health Products, Inc.
One Graham-Field Way
Atlanta, GA 30340-3140
Tel 1-770-368-4700
Fax 1-770-368-2386
www.grahamfield.com

**If you have questions regarding a bed's warranty,
contact Basic American Medical Products at 1-770-368-4700.**

RECOMMENDED MAINTENANCE

Regular maintenance of the Long Term Bed is necessary to ensure continuing proper and safe operation. Read and observe the following recommended maintenance schedule.

ITEM	RECOMMENDED INSPECTION PERIODS			MAINTENANCE		
	Inspect on Receipt	Every 3 Months	Every 6 Months	Performed by	Date	Comments
Maintenance Inspection of All Components at Receipt of Shipment						
Ensure all parts / components are included (see "Unpacking The Bed").	X					
Check all bed components for obvious damage.	X					
Inspect the power cord for any cuts and / or damage.	X					
Check to see all actuator / motor cables are routed and connected properly to the control box.	X					
Mechanical Inspection of Assemblies						
Inspect all welds on the sleeping surface, frame, and base assemblies for stress fractures.			X			
Inspect all fasteners for wear and looseness.			X			
IMPORTANT: Lubricate all pivot points, actuator / motor clevis pins, and control arm clevis pins as needed. White Lithium Grease is recommended.			X			
Mechanical Inspection of Casters and Pedal Locking Mechanism						
Check the pedal locking mechanism to ensure it engages and disengages properly.		X				
Check the casters and stationary foot pads on both the head end and foot end for any damage, wear, or debris. Replace if needed.		X				
Check all rolling casters to ensure that they roll properly and are unobstructed.		X				
Electrical Inspection of Control Box, Hand Control Pendant, and Staff Control						
Check the external power cord that plugs into the control box for any chafing, cuts, or wear. Replace if damaged.		X				
Ensure all attaching hardware is securely tightened.		X				
Check all electrical connections for wear or fractures.		X				
Check the external backup battery (if you have one). Replace if needed.		X				
Check the hand control pendant cable for chafing, cuts, or wear.		X				
Check all hand control pendant functions - check to ensure each button and associated function work properly (i.e. head section rises when the HEAD UP button is activated).		X				
Electrical Inspection of Actuators / Motors						
Check the actuator / motor cables for any chafing, cuts, or wear.		X				
Check the range of movement on all motors to ensure they do not bind in the Full Up or Full Down positions.		X				



**Basic
American**[™]
by graham-field

*Manufactured by:
GF Health Products, Inc.
One Graham-Field Way
Atlanta GA 30340-3140*



1.770.368.4700

Information contained herein is subject to change.
The most current and complete product information can be found on our website.
www.grahamfield.com



© 2017, GF Health Products, Inc. All Rights Reserved.
Basic American Medical Products, Graham-Field, Slide-W-I-D-E, and Zenith are trademarks of GF Health Products, Inc.
GF Health Products, Inc. is an ISO 13485 Certified Company.