

# microAIR® MA50 Series

MA50, MA51, MA55 (with Low Air Loss)

en **Alternating Pressure Mattress  
User Manual**



This manual **MUST** be given to the user of the product.  
**BEFORE** using this product, read this manual and save for future reference.



**Yes, you can.®**

©2017 Invacare Corporation

All rights reserved. Reproduction, duplication or modification in whole or in part is prohibited without prior written permission from Invacare. Trademarks are identified by ™ and ®. All trademarks are owned by or licensed to Invacare Corporation or its subsidiaries unless otherwise noted.

Making Life's Experiences Possible is a registered trademark in the U.S.A.

---

# Contents

---

<b>1 General</b>	<b>4</b>
1.1 Symbols	4
<b>2 Safety</b>	<b>5</b>
2.1 General Guidelines	5
<b>3 Overview</b>	<b>11</b>
3.1 Label Location	11
3.2 Technical Data	12
<b>4 Setup</b>	<b>14</b>
4.1 Unpacking	14
4.2 MA50 Mattress Overlay System Installation	15
4.3 Mattress Replacement System Installation(MA51 and MA55)	16
4.4 Bed Side Rails Installation	17
4.5 Power Unit Installation	17
4.6 Connecting the Hose	18
4.7 Connecting the Power Cord	19
4.8 EMC Information	20
<b>5 Usage</b>	<b>21</b>
5.1 Using the Front Panel	21
5.1.1 Power Button	22
5.1.2 Static/Alternating Pressure Button	22
5.1.3 Adjusting the Minimum Pressure Setting (A/P Low)	23
5.1.4 Firm/Soft Buttons	23
5.1.5 Fowler Button	23
5.1.6 Max Inflate Button	24
5.1.7 Mode Button (Max Inflate/Low Air Loss)	24
5.1.8 Lock Button	25
5.1.9 Alarm Silence Button	25
5.1.10 Power Fail LED	25
5.1.11 Low Pressure LED	25

5.2 Powering Up the System	25
5.3 Placing the Patient on the Mattress	26
5.4 Transferring Patient From/To a Gurney	27
5.5 Transferring Patient From/To a Wheelchair	27
5.6 Preparing for CPR Procedure	28
5.7 About Power Outage and Transportation	28
<b>6 Maintenance</b>	<b>29</b>
6.1 Service Life	29
6.2 Cleaning the System	29
6.3 Disposal	31
6.4 Storing the System	32
<b>7 Troubleshooting</b>	<b>33</b>
7.1 Troubleshooting	33
<b>8 Limited Warranty</b>	<b>34</b>
8.1 Limited Warranty	34

---

# 1 General

---

## 1.1 Symbols

Signal words are used in this manual and apply to hazards or unsafe practices which could result in personal injury or property damage.



### **DANGER!**

– Danger indicates an imminently hazardous situation which, if not avoided, will result in death or serious injury.



### **WARNING!**

– Warning indicates a potentially hazardous situation which, if not avoided, could result in death or serious injury.



### **CAUTION!**

– Caution indicates a potentially hazardous situation which, if not avoided, may result in property damage or minor injury or both.



Gives useful tips, recommendations and information of efficient, trouble-free use.



THE INFORMATION CONTAINED IN THIS DOCUMENT IS SUBJECT TO CHANGE WITHOUT NOTICE.

## 2 Safety

### 2.1 General Guidelines



**DANGER!**

**Risk of Death, Injury or Damage**

Improper use of this product may cause injury or damage.

- If you are unable to understand the warnings, cautions or instructions, contact a healthcare professional, dealer or technical personnel before attempting to use this equipment.
- Do not use this product or any available optional equipment without first completely reading and understanding these instructions and any additional instructional material such as user manuals, service manuals or instruction sheets supplied with this product or optional equipment.



**DANGER!**

**Risk of Death, Injury or Damage**

To avoid risk of death, injury or damage from use of malfunctioning or damaged product:

- DO NOT use damaged or malfunctioning product.
- Stop using the product immediately if the product becomes damaged or malfunctions.
- Contact a qualified technician or Invacare for repair if product is damaged or malfunctioning.



**DANGER!**

**Risk of Death, Injury or Damage**

Lighted cigarettes can cause a fire or other related hazards resulting in death, injury or damage.

- DO NOT smoke while using this product.
- DO NOT allow others to smoke near this product



**DANGER!**

**Risk of Death, Injury or Damage**

Parts and accessories designed by other manufacturers have NOT been tested by Invacare. Use of NON-Invacare parts and accessories may result in injury or death.

- Use ONLY Invacare rails, mattresses, bed extenders, other accessories and parts with Invacare products.



**DANGER!**

**Risk of Death, Injury or Damage**

Conditions such as restlessness, mental deterioration and dementia or seizure disorders (uncontrolled body movement), sleeping problems, and incontinence can significantly impact a patient's risk of entrapment. Pediatric patients or patients with small body size may also have an increased risk of entrapment.

- Monitor patients with these conditions frequently.
- Place mattress deck in the flat position when left unattended.



**DANGER!**

**Risk Of Death, Injury Or Damage**

To avoid risk of injury due to pressure ulcers:  
– Skin condition should be checked frequently after the installation and during use of this product.

- Proper product evaluation becomes more important as the needs of the individual become more complex. Work with your therapist, physician and equipment supplier to assure that a product matches your individual needs.
- Consult your therapist or physician if you have any questions regarding individual limitations and needs.



**DANGER!**

**Risk Of Death Or Injury**

To avoid risk of death or injury from choking or ingestion of small parts or materials.

- Closely supervise children, individuals with mental disabilities or pets.



**DANGER!**

**Risk Of Death Or Injury**

To avoid risk of death or injury due to misuse or modification:

- DO NOT use this product in any way other than described in this manual.
- DO NOT modify the product or any components of the product.



**WARNING!**

**Risk Of Death Or Injury**

To avoid risk of death or injury due to product misuse:

- Closely supervise children, individuals with mental disabilities.
- Monitor patients using this device who are unable to hear or see alarms or communicate discomfort.

**Contraindications**



**WARNING!**

**Risk Of Injury Or Death**

To avoid injury or death from misuse of product:

- Always consult the patient's physician before using the microAir mattress system.

## Electrical

**DANGER!****Risk Of Shock Injury**

To avoid injury due to shock hazard, this product is equipped with three prong (grounding) plugs. It is the responsibility and obligation of the customer to contact a qualified electrician and have the two prong receptacle replaced with a properly grounded three prong receptacle that is in accordance with the National Electric Code where a two prong wall receptacle is encountered:

- Use only a Underwriter Laboratory (UL) approved three prong extension cord having the same or higher electrical rating as the product being connected if you must use an extension cord.
- DO NOT use three prong to two prong adapters.

**DANGER!****Risk of Death, Injury Or Damage**

To avoid death, injury or damage due to electrical shock:

- DO NOT disassemble controls or other components.
- DO NOT insert items into any openings of the control unit.
- Contact qualified technician or Invacare for repair.

**DANGER!****Risk of Death, Injury Or Damage**

To reduce the risk of electrical shock:

- Always unplug the bed from the electrical outlet before any maintenance.
- Ensure all power cords are routed and secured properly.
- Inspect power cords and outlets for damage. Stop using the product immediately if the cord or outlet is damaged. Contact qualified technician or Invacare for service.

**WARNING!****Risk Of Injury Or Damage**

To avoid electrical damage, product damage, shock and/or personal injury:

- Keep all bed components and accessories a minimum of 12 inches (30,5 cm) away from hot or heated surfaces.

**WARNING!****Risk Of Injury Or Damage**

To avoid electrical damage, product damage, shock and/or personal injury:

- Unplug the product if liquid is spilled in or around the product.
- Clean up the spill and allow the product and surrounding area to dry thoroughly.



**WARNING!**

**Risk Of Injury Or Damage**

To avoid personal injury or damage:

- Check for leakage from electrical components such as batteries and circuit boards.
- Remove product from service and contact dealer or Invacare for repair if leakage is found.

**Entrapment**



**DANGER!**

**Risk of Death, Injury or Damage**

Proper patient assessment and monitoring, and proper maintenance and use of equipment is required to reduce the risk of entrapment.

Variations in bed rail dimensions, and mattress thickness, size or density could increase the risk of entrapment.

- Visit the FDA website at <http://www.fda.gov> to learn about the risks of entrapment.



Refer to the **Bed Rail Entrapment Risk Notification Guide** at [www.invacare.com](http://www.invacare.com) for additional safety information.



**WARNING!**

**Risk Of Death, Injury Or Damage**

To avoid risk of death, injury or damage from product misuse or entrapment:

- Read and understand the User Manual prior to using this product. User manuals are available at [www.invacare.com](http://www.invacare.com) or your dealer.
- Refer to user manuals for beds and rails for additional product safety information.
- Proper patient assessment and monitoring is required. Work with therapist, physician and other medical staff to perform assessment and patient monitoring.
- Variations in bed rail dimensions, mattress thickness, size or density could increase risk of entrapment.
- The Invacare mattress **MUST** fit firmly against the bed frame **AND** bed side rails to prevent patient entrapment. Follow the manufacturer's product instructions.
- After any adjustments, repair or service and before use, make sure all attaching hardware is tightened securely.



**WARNING!****Risk of Death or Injury**

To avoid risk of death or injury from entrapment or falling:

- Invacare suggests rails be in the raised or guard position whenever a patient is on the bed.
- Health care professionals assigned to each case should make the final determination whether side or assist rails are warranted after assessing patient risks of entrapment and falls in accordance with State patient restraint legislation or facility interpretation of such legislation.

**Fire Hazard****DANGER!****Risk Of Product Damage, Injury, Or Death**

To avoid damage, injury, or death from explosion:

- Do not use with flammable anesthetics.

**DANGER!****Risk Of Product Damage, Injury, Or Death**

To avoid damage, injury, or death from fire:

- Only use nasal mask or half bed tent type with oxygen administering equipment.
- Do not allow oxygen tent to extend below mattress support level.

**Installation****WARNING!****Risk Of Injury Or Damage**

To avoid serious injury or damage from tripping, entanglement and/or pinched, or severed cords:

- Ensure that all cord(s) are routed and secured properly.
- Keep all moving parts, including the main frame, mattress deck, and all drive shafts, free of obstruction (i.e. blankets/sheets, tubing, wiring, cords, etc.) during operation of the product.



**WARNING!**

**Risk Of Injury Or Damage**

To avoid serious injury or damage from airborne pollutants and/or fumes and for optimal performance:

- Locate and position the product in a well ventilated space so that the air intake and exhaust are not blocked or obstructed.
- Place product in well ventilated area.
- Avoid use in presence of pollutants, smoke or fumes, flammable anesthetics, cleaning agents or chemical vapors.
- Keep openings free from lint, hair or similar foreign items.
- Keep product at least 12 inches (30,5 cm) away from walls, draperies and furniture.



**WARNING!**

**Risk Of Damage**

To avoid damage to the mattress:

- DO NOT strap the mattress to the *bed frame* at the end and foot ends.
- Secure mattress straps to the *bed deck* at the head and foot ends and to the *bed frame* at the center of the bed.

**Repair and Service**



**DANGER!**

**Risk of Death, Injury, or Damage**

To avoid death, injury or damage due to improper maintenance or inspection. Always maintain and inspect equipment per the instructions in this manual. Contact a qualified technician or Invacare if any of the following issues are present:

- Loose or missing parts such as end caps, knobs, bolts, screws etc., should be secured or replaced.
- Sharp edges or surfaces should be corrected or replaced.
- Parts showing excessive wear should be replaced.
- Warped or otherwise damaged parts should be replaced immediately.



**WARNING!**

**Risk Of Injury Or Damage**

To avoid injury or damage due to collapse or missing hardware:

- After any adjustments, repair or service and before use, make sure all attaching hardware is tightened securely.

## 3 Overview

### 3.1 Label Location



Labels are subject to change without notice. This label is on the back of the unit and also contains the serial number.



#### **WARNING!**

#### **Risk of Injury, Damage or Death**

Missing or damaged labels may contribute to injury, damage or death.

– Ensure labels are present and legible.

**DANGER- EXPLOSION HAZARD: DO NOT use in the presence of flammable anesthetics. CAUTION: Equipment should be connected to a properly grounded receptacle (3-prong). Risk of Electrical shock. DO NOT remove back. Disconnect air hose before administering CPR.**



## 3.2 Technical Data

### Electrical Specifications

	MA50/MA51/MA55
<b>INPUT VOLTAGE AC:</b>	90 V
<b>INPUT FREQUENCY:</b>	60 Hz
<b>CURRENT:</b>	1 A
<b>MAXIMUM POWER CONSUMPTION:</b>	5 ± 3 W
<b>CIRCUIT PROTECTION:</b>	Dual fused, 250 V, 1 A slow blow fuse
<b>MODE OF OPERATION:</b>	Continuous

### Environmental Specifications

<b>OPERATING CONDITIONS</b>	MA50/MA51/MA55
AMBIENT TEMPERATURE:	50–104° F
RELATIVE HUMIDITY:	30–75% Non-Condensing
ATMOSPHERIC PRESSURE:	70–106 kPa
<b>STORAGE AND SHIPPING CONDITIONS</b>	
AMBIENT TEMPERATURE:	-40–158° F
RELATIVE HUMIDITY:	10–100% Non-Condensing
ATMOSPHERIC PRESSURE:	50–106 kPa

## Performance Specifications

	MA50/MA51/MA55
<b>WEIGHT CAPACITY</b>	350 lbs
<b>PRESSURE ZONE:</b>	2
<b>MAXIMUM FLOW:</b>	8 ± 4 LPM
<b>MAXIMUM FLOW PRESSURE:</b>	35 ± 5 mmHg
<b>MAXIMUM FLOW TIMER:</b>	45 minutes
<b>SUPPORT SURFACE INFLATION TIME:</b>	20–45 minutes
<b>PATIENT COMFORT CONTROL PRESSURES</b>	
<b>SOFT PRESSURE:</b>	8 ± 4 mmHg
<b>FIRM PRESSURE:</b>	32 ± 4 mmHg
<b>CYCLE TIME:</b>	5, 10, 15, 20 minutes
<b>PATIENT CONTACT:</b>	Control unit and mattress have Latex-Free components

## Mechanical Specifications

CONTROL UNIT	MA50	MA51	MA55
<b>DIMENSIONS (L X W X H):</b>	9" x 5" x 5"		
<b>WEIGHT:</b>	5 lbs		
<b>POWER CORD:</b>	10–14 Feet Long, Hospital Grade		
<b>CONNECTION:</b>	Two ¼" Flow Couplings		Three ¼" Flow Couplings
<b>PACKAGING:</b>	1 piece/box		
<b>AIR FILTER:</b>	None		

## 4 Setup

### 4.1 Unpacking

1. Remove any loose packing from the carton.
2. Carefully remove all components from the carton.
3. Inspect all components for damage. Contact dealer or Invacare if components are damaged. DO NOT use product.



#### **DANGER!**

##### **Risk of Injury or Damage**

Continued use of the product with damaged parts could lead to the product malfunctioning, causing injury to the user and/or caregiver.

- Check ALL product components and carton for damage, and test components before use. In case of damage or if the product is not working properly, contact a qualified technician or Invacare for repair.



#### **WARNING!**

##### **Risk of Injury or Damage**

To avoid damage or personal injury from strain or mishandling of product:

- Use proper lifting techniques (lift with your legs) when handling the product or accessories.
- Obtain assistance when necessary to lift or handle product safely.



#### **WARNING!**

##### **Risk of Injury or Damage**

To avoid damage or personal injury from misuse:

- DO NOT plug the power cord into a power source until assembly is complete.
- DO NOT attempt to operate product controls prior to completion of assembly.

## 4.2 MA50 Mattress Overlay System Installation



### CAUTION!

#### Risk Of Damage

To avoid damage to the system:

- Do not replace mattresses, covers or control units with other models or other brands.
- Contact your supplier to get the correct replacement, if needed.



The overlay system comes with the following straps - head end elastic strap, foot end elastic strap and two buckle straps.

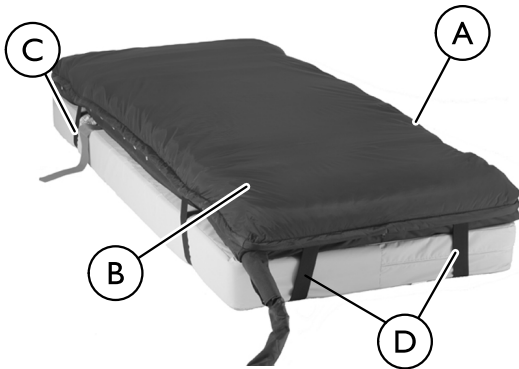

1. If necessary, lower the side rails to facilitate installation of the mattress.
2. Place the mattress overlay **A** directly over the existing 3 to 5-inch foam mattress **B**.
3. Loop the head end elastic strap **C** around the head end of the existing foam mattress.
4. Loop the foot end elastic strap **D** around the foot end of the existing foam mattress.
5. Secure the overlay mattress to the existing foam mattress using the two buckle straps.



Ensure that the side rails can move freely.

### 4.3 Mattress Replacement System Installation (MA51 and MA55)



**CAUTION!**

**Risk Of Damage**

To avoid damage to the mattress:

- Do not strap the mattress to the bed frame at the head and foot ends .
- Secure all mattress straps.
- Secure the straps to the bed deck at the head and foot ends and to the frame at the center of the bed.



The powered mattress comes with ten nylon buckle straps.

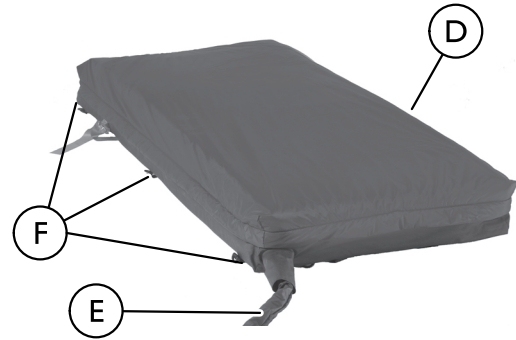
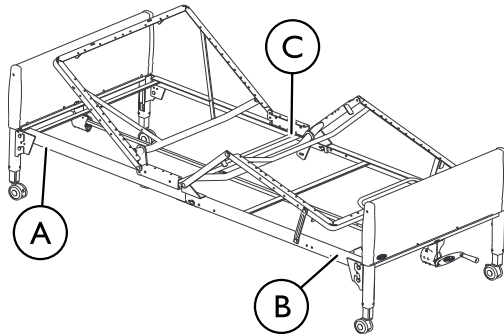

1. Remove the original foam mattress from the bed.
2. If necessary, lower the side rails to facilitate installation of the mattress.
3. Unroll the powered mattress **D** and place it on the bed frame.





Ensure that the hose **E** is towards the foot end of the bed.

4. Use the buckle straps **F** to secure the powered mattress to the bed deck in the following locations:
  - Head End - Head End Bed Deck **A**
  - Foot End - Foot End Bed Deck **B**
  - Center - Center of the Bed Frame **C**





#### 4.4 Bed Side Rails Installation

 For more information regarding bed rail safety, refer to the **Bed Rail Entrapment Risk Notification Guide** at [www.invacare.com](http://www.invacare.com).

 Refer to the instructions provided with the side rails for the installation procedure.

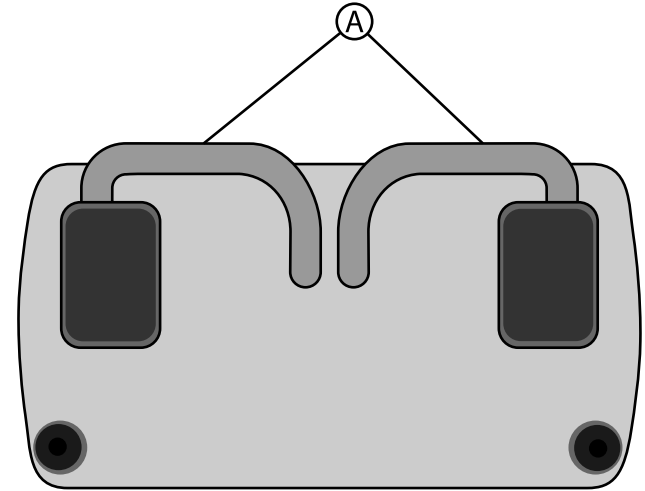
#### 4.5 Power Unit Installation



1. Swing out the bed hooks  on the back of the control unit.
2. Place the control unit on the footboard

 If the bed does not have a footboard, place the control unit on a flat surface, leaving room for the hose to hang down. **DO NOT** place control unit on mattress.

## 4.6 Connecting the Hose



### CAUTION!

#### Risk Of Injury Or Damage

To prevent falling, stepping on the hose, or causing other injuries or damage:

- Ensure that the hose connecting the control unit to the mattress is routed such that it cannot be stepped on, kinked, squeezed or otherwise damaged.

1. Locate the hose (A) at the foot end of the mattress.
2. Locate the control unit connectors (B) on the right side of the control unit.
3. Squeeze and hold the tabs (C) on the hose connectors (D).
4. Push the hose connectors onto the control connectors until an audible click is heard.



The audible click indicates that the hose connectors are properly engaged with the control connectors.

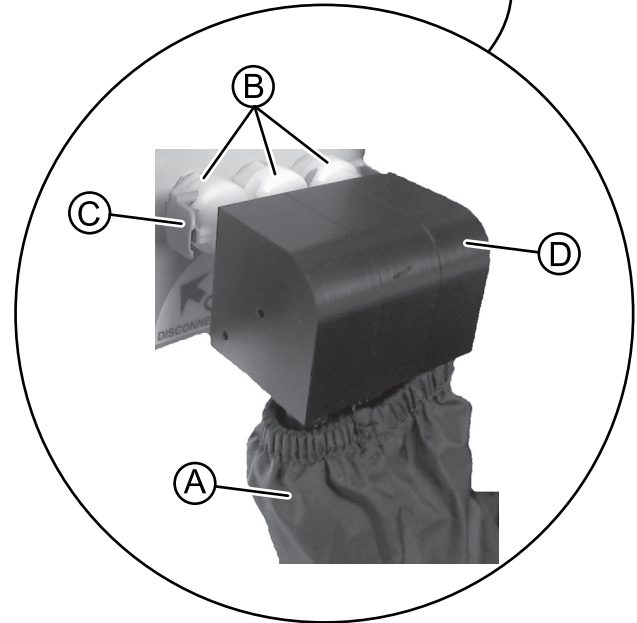

## 4.7 Connecting the Power Cord



### **WARNING!**

#### **Risk Of Injury Or Damage**

To avoid serious injury or product damage from tripping, entanglement and/or pinched, or severed cords:

- Ensure that all cord(s) are routed and secured properly.
- Keep all moving parts, including the main frame, mattress deck, and all drive shafts, free of obstruction (i.e. blankets/sheets, tubing, wiring, cords, etc.) during operation.

1. Examine the hospital grade power cord supplied with the control unit.
2. Perform one of the following:
  - If the plug is damaged—Call your supplier for a replacement hospital grade cord.
  - If the plug is not damaged—Plug the end of the supplied hospital grade power cord into the power outlet on the side of the control unit.
3. Plug the other end of the plug into a properly grounded outlet on the wall.



An amber LED on the control unit will illuminate once unit is plugged in indicating that the system is in Stand By mode.

## 4.8 EMC Information



Use of portable and mobile radio frequency equipment can effect medical electrical equipment.



### **CAUTION!**

#### **Risk Of Damage**

Electronic equipment may be influenced by Radio Frequency Interference (RFI).

- Caution should be exercised with regard to the use of portable communications equipment in the area around such equipment.
- If RFI causes erratic behavior, unplug the product immediately. Leave unplugged while transmission is in progress.

Medical Electrical Equipment needs to be installed and used according to the EMC information in this manual.

This equipment has been tested and found to comply with EMC limits specified by IEC/EN 60601–1–2 for Type BF equipment. These limits are determined to provide reasonable protection against electromagnetic interference in a typical home healthcare environment. This product is not intended for use in a professional healthcare environment.

Portable and mobile RF communications equipment can effect the operation of this product.

Other devices may experience interference from even the low levels of electromagnetic emissions permitted by the above standard. To determine if the emissions from product are causing the interference, turn the product off. If the interference with the other device operation stops, then the product is causing the interference. In such rare cases, interference may be reduced or corrected by one of the following measures:

- Reposition, relocate, or increase the separation between the devices.
- Connect either line powered device to a different electrical power circuit.

Contact Invacare for any additional EMC information or EMC tables for the device environment.

## 5 Usage

### 5.1 Using the Front Panel

#### DETAIL "A" — MA50 AND MA51 FRONT PANEL

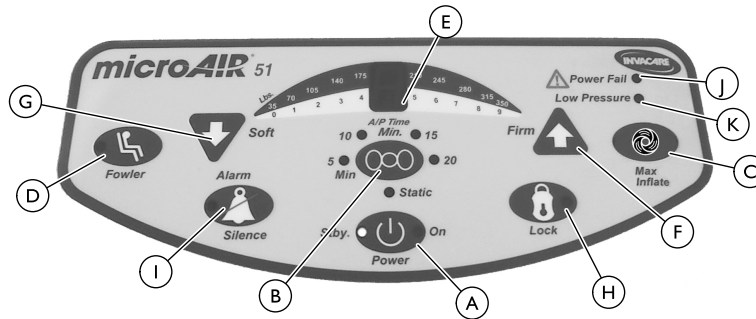

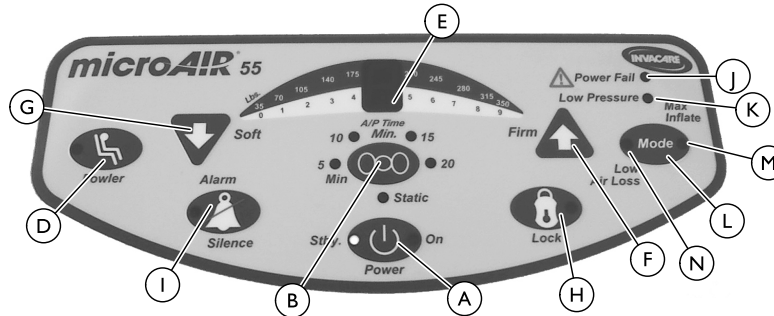

#### DETAIL "B" — MA55 FRONT PANEL



### 5.1.1 Power Button

1. To turn the control unit on or off, press and release the Power button .

 Once the unit is plugged in, an Amber LED on the control unit is lit indicating that the system is in stand by mode. Once the Power button is pressed and released, a green LED illuminates indicating that the control unit is on.

 If the power comes on after a power outage, the control unit will go through its system initialization routine for a few seconds and then resume the desired function.

### 5.1.2 Static/Alternating Pressure Button



1. Press the Alternating Pressure button  to select between Static Mode and one of four Alternating Pressure Times—5, 10, 15, and 20 minutes.

 The alternating pressure times indicate the frequency of deflation or inflation of half of the air cushions (even or odd numbered). For example, 10 minutes is selected. In this example, the even numbered air cushions in the mattress will deflate, while the odd numbered cushions remain at constant pressure. When 10 minutes has elapsed, the even numbered air cushions will inflate while the odd numbered cushions remain at constant pressure. When 10 minutes has elapsed again, the odd numbered air cushions deflate while the even numbered cushions remain at constant pressure. The air cushions continue to inflate or deflate like this as long as an alternating pressure time has been selected. At all times, half of the air cushions remain at a constant pressure when an alternating pressure time has been selected.



In Static Mode, all air cushions in the mattress are maintained at constant pressure. The Static LED is illuminated Green.

### 5.1.3 Adjusting the Minimum Pressure Setting (A/P Low)

The minimum pressure setting during Alternating Pressure is set to 0 (8±4 mmHg) at the factory. This means that the mattress will deflate as much as possible during the deflation time when using 5, 10, 15 or 20 minute Alternating Pressure times. The setting can be changed so the mattress will only deflate to 25%, 50%, 75% of the selected pressure setting.

1. Ensure the Standby LED is lit.
2. Perform one of the following:
  - MA50 and MA51 - Press and hold the Max Inflate  and Fowler buttons .
  - MA55 - Press and hold the Mode and Fowler buttons.
3. Read the LCD Display . The LCD Display will flash:
  - 0 if the current setting is 0 (8±4 mmHg).
  - 2 if the current setting is 25% of the selected pressure.
  - 5 if the current setting is 50% of the selected pressure.
  - 7 if the current setting is 75% of the selected pressure.
4. Press the Static/Alternating Pressure button to toggle between the four settings.
5. Press the Power button to save the setting.

### 5.1.4 Firm/Soft Buttons

1. Select comfort pressure settings by pressing Firm  or Soft  button.
  - Soft Button - Pressing this button reduces the pressure setting in the mattress
  - Firm Button - Pressing this button increase the pressure setting in the mattress



The patient comfort pressure ranges from Soft (level 0 = 8 ±4 mmHg) to Firm (level 9 = 32 ±4 mmHg). The Comfort Control LED displays the patient comfort pressure levels from 0 to 9 and provides a guide to the caregiver to set approximate comfort pressure level depending on the patient weight. If the patient's weight to height ratio is above average, increase the pressure setting by approximately 20%.

### 5.1.5 Fowler Button

1. Press the Fowler button  to activate the patient fowler mode.



The Fowler LED illuminates when in this mode. When this mode is activated, the control unit increases the pressure in the mattress to prevent the patient from bottoming out.

### 5.1.6 Max Inflate Button

 This button is on the MA50 and MA51 only.

1. Press the Max Inflate button  to select the Max Inflate mode and inflate the mattress rapidly to maximum firmness (pressurized to 35 ±5 mmHg). A series of beeps sound every three minutes as a reminder that the Max Inflate mode is active. After 30 minutes, the Max Inflate mode deactivates and the control unit defaults to the previous setting.

 It takes 20–45 minutes for the mattress to inflate fully (inflation time depends on size of mattress).

Max Inflate mode can be manually disengaged by pressing the Max Inflate button. This will deactivate the Max Inflate LED.

It is recommended that Max Inflate setting be used during patient ingress/egress, patient wound care, patient turning or patient cleaning.

2. Press the Max Inflate button again to manually disengage Max Inflate mode.

 This will deactivate the Max Inflate LED.

### 5.1.7 Mode Button (Max Inflate/Low Air Loss)

 The Mode button is on the MA55 system only.

1. Press the Mode button  to select the Max Inflate mode or the Low Air Loss mode.



- Max Inflate Mode - In this mode, the mattress inflates rapidly to maximum firmness (pressurized to 35 ±5 mmHg). A series of beeps sound every three minutes as a reminder that the Max Inflate mode is active. After 45 minutes, the Max Inflate mode deactivates and the control unit defaults to the previous setting.

 It takes 20-45 minutes for the mattress to inflate fully (inflation time depends on size of mattress).

It is recommended that Max Inflate setting be used during patient ingress/egress, patient wound care, patient turning or patient cleaning.

- Low Air Loss Mode - In this mode, the mattress goes into on-demand low air loss relief mode.

2. Press the Mode button to manually disengage Max Inflate or Low Air Loss mode.

 This will deactivate the Max Inflate  and Low Air Loss LEDs .





### 5.1.8 Lock Button

1. Press the Lock button  to lock out all control unit functions, including the On button, to prevent any tampering with the settings. Press the button for approximately 3-5 seconds for the Lock LED to activate.

 The Lock LED illuminates when in this mode.

### 5.1.9 Alarm Silence Button

1. Press the Alarm Silence button  to silence the alarm that sounds in the event of power failure or when the hose is disconnected from the control unit.

 The Alarm LED illuminates when in this mode.

### 5.1.10 Power Fail LED

In the event of power outage, an alarm sounds and Power Fail LED  flashes Amber. The control unit has internal memory and retains the previous settings during the power outage.

 During a power outage, the mattress retains the air as long as the mattress is connected to the control unit.

 Periodically test alarm by unplugging the power cord from the wall outlet while unit is on. See troubleshooting section of this manual if alarm fails to sound.

### 5.1.11 Low Pressure LED

In the event that the mattress hose disconnects, an alarm sounds and Low Pressure LED  flashes Amber. Once the low pressure problem is fixed, the control unit resumes operation in the previously set mode.

 Periodically test alarm by disconnecting the mattress hose. It may take up to 15 minutes for unit to lose enough air for alarm to sound. See troubleshooting section of this manual if alarm fails to sound.

## 5.2 Powering Up the System

1. Turn on the power to the system by pressing the Power button on the control unit.

 Once the button is released, a green led illuminates when the unit is on.

### 5.3 Placing the Patient on the Mattress

1. Perform one of the following:
  - MA50 or MA51 - Press the Max Inflate button to turn on the control unit to maximum flow.
  - MA55 - Press the Mode button to select Max Inflate Mode



In this mode, the Max Inflate Led lights up.

2. After the mattress is fully inflated, place the patient on the mattress.
3. Ensure that the patient's feet are towards the foot end of the mattress (the end with the hose).
4. Center the patient on the bed from side-to-side and head-to-foot.



Special positioning may be required with contracted patients to provide comfortable positions.

5. After placing the patient, make certain no objects will fall under the patient, such as feeding tubes, IV's etc.
6. Wait five minutes for the mattress pressure to stabilize.
7. Once the mattress inflates to its normal size, set the comfort pressure to the desired comfort level.
8. Wait five minutes for the mattress pressure to stabilize.

9. Verify that the patient has not bottomed out by performing the following steps:
  - a. Ensure that the patient is lying flat on his/her back in the middle of the mattress.
  - b. Place four fingers between the air cushions directly underneath the sacral region of the patient's body.
  - c. Ensure that there is 3 to 4-finger width clearance between the bottom of the patient and the bed frame.
  - d. Adjust the comfort setting, if needed.
  - e. Wait five minutes for the mattress pressure to stabilize.
  - f. Repeat Steps A-E until patient has not bottomed out and patient comfort is achieved.
10. If the patient feels that the bed is too soft/hard, press the Soft or Firm button to adjust the comfort settings.
11. Wait five minutes for the mattress pressure to stabilize.
12. Use a regular pillow to help support and stabilize the patient's head.

## 5.4 Transferring Patient From/To a Gurney



### **WARNING!** **Risk Of Injury**

To avoid injury from falling:

- ALWAYS engage the wheel locks of the bed and the wheel locks of the gurney before transferring the patient between the bed and the gurney.

1. Engage the wheel locks of the bed. Refer to the owner's manual provided with the bed.
2. Engage the wheel locks of the gurney. Refer to the owner's manual provided with the gurney.
3. Press the Max Inflate or Mode button to achieve maximum mattress pressure.
4. Raise or lower the bed to match the gurney height. Refer to the owner's manual provided with the bed.
5. When the mattress has reached maximum firmness, perform one of the following:
  - Bed to Gurney Transfer - Slide the patient onto the gurney.
  - Gurney to Bed Transfer - Slide the patient onto the bed.

## 5.5 Transferring Patient From/To a Wheelchair



### **WARNING!** **Risk Of Injury**

To avoid injury from falling:

- ALWAYS engage the wheel locks of the bed and the wheel locks of the wheelchair before transferring the patient between the bed and the wheelchair.

1. Engage the wheel locks of the bed. Refer to the owner's manual provided with the bed.
2. Engage the wheel locks of the wheelchair, if applicable. Refer to the owner's manual provided with the wheelchair.
3. Press the Max Inflate or Mode button to achieve maximum mattress pressure.
4. Raise or lower the bed to match the wheelchair height. Refer to the owner's manual provided with the bed.
5. When the mattress has reached maximum firmness, perform one of the following:
  - Bed to Wheelchair Transfer - Slide the patient onto the wheelchair.
  - Wheelchair to Bed Transfer - Slide the patient onto the bed.

## 5.6 Preparing for CPR Procedure

1. Press and hold the tabs **A** on hose connector **B** while pulling the hose **C** from the control unit.
2. Twist the CPR connector **D** at the foot end of the overlay **E** and all air will be evacuated in the torso and chest region of the overlay within 18 seconds.

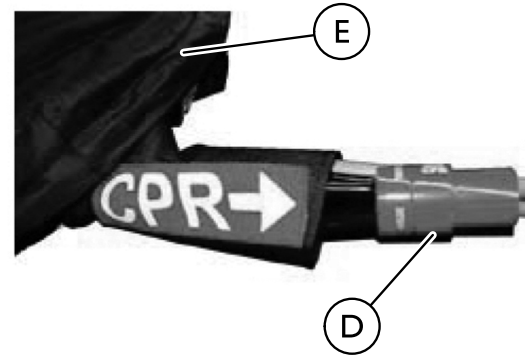
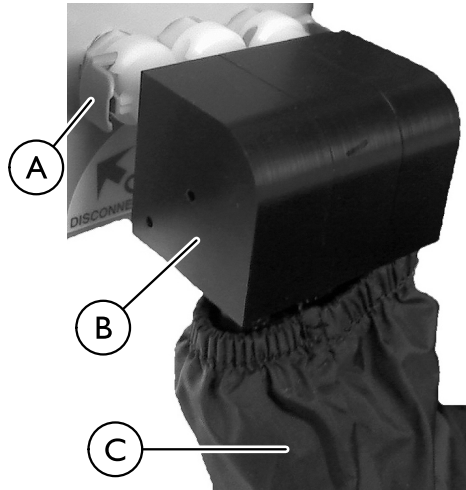

### **DANGER!**

#### **Risk of Death or Injury**

To reduce the risk of death or injury:

- Move patient to appropriate surface to perform CPR if unable to deflate mattress.

## 5.7 About Power Outage and Transportation

If the hoses remain connected to the control unit, the mattress retains air during a power outage, during transportation, when the control unit is unplugged or when the control unit is turned Off. Additionally, on the MA51 and MA55, if the hose becomes disconnected or damaged and the mattress deflates, the mattress has a 2 inch foam pad to provide patient support.

## 6 Maintenance

### 6.1 Service Life



**WARNING!**

**Risk Of Injury Or Damage**

Use of the product beyond this time period may cause product damage and injury.

- This product has an expected lifetime of one (1) years when used in accordance with safety instructions, maintenance intervals and correct use stated in this manual.
- Perform all maintenance according to the recommended schedule in this manual.



The effective product lifetime can vary according to the frequency and intensity of use.

### 6.2 Cleaning the System



**WARNING!**

**Risk Of Injury Or Damage**

To avoid injury or damage from sharp objects:

- Check the underside of the mattress folds for sharp objects such as scissors, needles, etc. before cleaning or disassembling.
- Remove and discard sharp objects before proceeding with cleaning or disassembly.



**WARNING!**

**Risk Of Injury Or Damage**

To avoid infectious exposure:

- Do not clean the bed when the patient is occupying the bed.
- Inspect all equipment. Properly clean or remove any item soiled with the patient's blood or other body fluids.
- Treat all soiled bedding as if it is contaminated with pathogenic microorganisms.



Follow standard institutional wipe down and infection control procedures.

Follow the instructions provided by the cleaning solution manufacturer for proper use and dilution.

1. Remove the bedding.
2. If necessary, inflate the mattress.
3. Ensure that the control unit is off.
4. Unplug the power cord from the wall outlet.
5. Ensure that the underside of the mattress is clear of all sharp objects.
6. Examine the surface of the control unit and mattress assembly components for visible blood or body fluids.

7. Perform one of the following:
  - If blood is present, decontaminate the product.
    - a. Remove all visible soil with disposable paper towels.
    - b. Scrub the area with freshly prepared effective detergent disinfectant solution.
  - If blood is not present, remove any soil from the cover with paper towels.
  
-  If soiled, the cover should be removed, cleaned and decontaminated.
  
8. To avoid damage, the following steps are recommended for cleaning the mattress cover:
  - a. To disinfect the cover:
    - i. Using a clean sponge or paper towel, wipe down the cover with a dilute detergent solution of quaternary cleaner disinfectant or other germicidal detergent solution.
    - ii. Let the cover completely dry.
  - b. To launder the cover:
    - i. Using a clean sponge or paper towel, wipe down the cover with a dilute detergent solution of quaternary cleaner disinfectant or other germicidal detergent solution.
    - ii. Remove the cover and launder it using the following method:



**CAUTION!**

**Risk Of Damage**

- To avoid contaminating bedding, damaging fabric or damaging washing machine:
- Wash hands before working with clean bedding.
  - Do not overload the machine.
  - Do not use chlorine bleach.



**CAUTION!**

**Risk Of Damage**

- To avoid damage to product:
- DO NOT use cleaning agents containing phenols, alcohols, bleaches or other abrasive materials.
  - DO NOT use granules.
  - 1% Chlorine Solution used on a regular basis can diminish the life of the product if not rinsed and dried properly.
  - Keep product clear of open heat sources.

- i. Place the cover in a washing machine.
- ii. Wash with warm water (below 120°F).
- iii. Add detergent and disinfectant according to the manufacturer's instructions.
- iv. Remove excess water.
- v. Set the dryer to the lowest setting (below 120°F).
- vi. Dry the cover until it is completely dry.

9. Perform the following steps to clean the control unit and hose fittings:
  - a. Wipe all controls, chassis and hose fittings with a quaternary disinfectant solution.
  - b. Using a nylon brush, gently clean all crevices as they can harbor microorganisms.
  - c. Air dry all treated surfaces.
10. Perform the following steps to clean the mattress components (air cushions, mattress base, etc.):
  - a. Using a clean sponge or paper towel, wipe down the mattress components with a dilute detergent solution of quaternary cleaner disinfectant or other germicidal detergent solution.
  - b. Wipe the mattress components with a clean dry cloth.
11. Test alarm function for power fail and low pressure.

### 6.3 Disposal

Follow local governing ordinances and recycling plans regarding disposal of the product or components normally used in operation. The product does not generate waste or residue in operation. Any accessories not part of the product **MUST** be handled in accordance with the individual product marking for disposal.

This product has been supplied from an environmentally aware manufacturer that complies with the Waste Electrical and Electronic Equipment (WEEE) Directive 2012/19/EC.

This product may contain substances that could be harmful to the environment if disposed of in places (landfills) that are not appropriate according to legislation.

Please be environmentally responsible and recycle this product through your recycling facility at its end of life.

The disposal and recycling of used devices and packaging must comply with the applicable legal regulations.

## 6.4 Storing the System

1. Ensure that the control unit is off and disconnect the power cord from the wall outlet.
2. Clean the system. 6.2 Cleaning the System, page 29.
3. Disconnect the air hose connector(s) from the control unit and allow air to vent from the mattress.
4. Gently roll up the mattress with minimal handling and agitation.
5. Ensure the cover surface is inside the roll.
6. Store the unit, keeping the mattress with the control unit.



## 7 Troubleshooting

### 7.1 Troubleshooting

PROBLEM	CAUSE	SOLUTION
Mattress not inflating Not alternating properly	Mattress hose disconnected	Connect hose connectors and lock them in place
	Air hose kinked or split	Unkink hose or replace split hose
	Major leak in the air cushions or overlay pad	Replace leaking air cushions or overlay pad
	Kinked or split manifold	Unkink manifold or replace split manifold
	Has power and fuse is good, control unit does not come on	Send control unit back to factory for repair
	Not alternating, solenoid malfunction	Send control unit back to factory for repair
	No air, pump malfunction	Send unit for repair
No power	Control unit off	Check power source and turn on unit
	Power cord disconnected	Connect power cord to the power source
	No power in the power source	Check power source has power and turn it On
	Power outage	Wait till the power source has power
	Blown fuse	Replace blown fuse with an equivalent fuse
Alarm—Power Failure	Power cord disconnected	Connect power cord to the power source
	No power in the power source	Check power source has power and turn it On
	Power outage	Wait till the power source has power
	Blown fuse	Replace blown fuse with an equivalent fuse
Alarm—Hose Disconnected	Mattress hose disconnected	Connect hose connectors and lock them in place

## 8 Limited Warranty

### 8.1 Limited Warranty



PLEASE NOTE: THE WARRANTY BELOW HAS BEEN DRAFTED TO COMPLY WITH FEDERAL LAW APPLICABLE TO PRODUCTS MANUFACTURED AFTER JULY 4, 1975

This warranty is extended only to the original purchaser who purchases this product when new and unused from Invacare or a dealer. This warranty is not extended to any other person or entity and is not transferable or assignable to any subsequent purchaser or owner. Coverage under this warranty will end upon any such subsequent sale or other transfer of title to any other person.

This warranty gives you specific legal rights and you may also have other legal rights which vary from state to state.

Invacare warrants the mattress, mattress overlay and cover when purchased new and unused to be free from defects in materials and workmanship for a period of one year from the date of purchase from Invacare or a dealer, with a copy of the seller's invoice required for coverage under this warranty. Invacare warrants the control unit when purchased new and unused to be free from defects in materials and workmanship for a period of two years from the date of purchase from Invacare or a dealer, with a copy of the seller's invoice required for coverage under this warranty. If within such warranty period any such product shall be proven to be defective, such product shall be repaired or replaced, at Invacare's option. This warranty does not include any labor or shipping charges

incurred in replacement part installation or repair of any such product. Invacare's sole obligation and your exclusive remedy under this warranty shall be limited to such repair and/or replacement.

For warranty service, please contact the dealer from whom you purchased your Invacare product. In the event you do not receive satisfactory warranty service, please write directly to Invacare at the address on the back cover. Provide dealer's name, address, model number, and the date of purchase, indicate nature of the defect and, if the product is serialized, indicate the serial number.

Invacare Corporation will issue a return authorization. The defective unit or parts must be returned for warranty inspection using the serial number, when applicable, as identification within thirty days of return authorization date. DO NOT return products to our factory without our prior consent. C.O.D. shipments will be refused; please prepay shipping charges.

LIMITATIONS AND EXCLUSIONS: THE WARRANTY SHALL NOT APPLY TO PROBLEMS ARISING FROM NORMAL WEAR OR FAILURE TO ADHERE TO THE ENCLOSED INSTRUCTIONS. IN ADDITION, THE FOREGOING WARRANTY SHALL NOT APPLY TO SERIAL NUMBERED PRODUCTS IF THE SERIAL NUMBER HAS BEEN REMOVED OR DEFACED; PRODUCTS SUBJECTED TO NEGLIGENCE, ACCIDENT, IMPROPER OPERATION, MAINTENANCE OR STORAGE; OR PRODUCTS MODIFIED WITHOUT INVACARE'S EXPRESS WRITTEN CONSENT INCLUDING, BUT NOT LIMITED TO: MODIFICATION THROUGH THE USE OF UNAUTHORIZED PARTS OR ATTACHMENTS: PRODUCTS DAMAGED BY REASON OF REPAIRS MADE TO ANY COMPONENT WITHOUT THE SPECIFIC CONSENT OF

INVACARE; PRODUCTS DAMAGED BY CIRCUMSTANCES BEYOND INVACARE'S CONTROL; PRODUCTS REPAIRED BY ANYONE OTHER THAN AN INVACARE DEALER, SUCH EVALUATION SHALL BE SOLELY DETERMINED BY INVACARE.

THE FOREGOING EXPRESS WARRANTY IS EXCLUSIVE AND IN LIEU OF ALL OTHER EXPRESS WARRANTIES WHATSOEVER, WHETHER EXPRESS OR IMPLIED, INCLUDING THE IMPLIED WARRANTIES OF MERCHANTABILITY AND FITNESS FOR A PARTICULAR PURPOSE AND THE SOLE REMEDY FOR VIOLATIONS OF ANY WARRANTY WHATSOEVER, SHALL BE LIMITED TO REPAIR OR REPLACEMENT OF THE DEFECTIVE PRODUCT PURSUANT TO THE TERMS CONTAINED HEREIN. THE APPLICATION OF ANY IMPLIED WARRANTY WHATSOEVER SHALL NOT EXTEND BEYOND THE DURATION OF THE EXPRESS WARRANTY PROVIDED HEREIN. INVACARE SHALL NOT BE LIABLE FOR ANY CONSEQUENTIAL OR INCIDENTAL DAMAGES WHATSOEVER.

THIS WARRANTY SHALL BE EXTENDED TO COMPLY WITH STATE/PROVINCIAL LAWS AND REQUIREMENTS.

**Invacare Corporation**

**USA**

One Invacare Way

Elyria, Ohio USA

44035

800-333-6900

1148136-G 2017-05-02



**Making Life's Experiences Possible®**

[www.invacare.com](http://www.invacare.com)

**Canada**

570 Matheson Blvd E Unit 8

Mississauga Ontario

L4Z 4G4 Canada

800-668-5324



*Yes, you can.®*